

CNX 3000

Wireless Multimeter

Calibration Manual

LIMITED WARRANTY AND LIMITATION OF LIABILITY

Each Fluke product is warranted to be free from defects in material and workmanship under normal use and service. The warranty period is three years and begins on the date of shipment. Parts, product repairs, and services are warranted for 90 days. This warranty extends only to the original buyer or end-user customer of a Fluke authorized reseller, and does not apply to fuses, disposable batteries, or to any product which, in Fluke's opinion, has been misused, altered, neglected, contaminated, or damaged by accident or abnormal conditions of operation or handling. Fluke warrants that software will operate substantially in accordance with its functional specifications for 90 days and that it has been properly recorded on non-defective media. Fluke does not warrant that software will be error free or operate without interruption.

Fluke authorized resellers shall extend this warranty on new and unused products to end-user customers only but have no authority to extend a greater or different warranty on behalf of Fluke. Warranty support is available only if product is purchased through a Fluke authorized sales outlet or Buyer has paid the applicable international price. Fluke reserves the right to invoice Buyer for importation costs of repair/replacement parts when product purchased in one country is submitted for repair in another country.

Fluke's warranty obligation is limited, at Fluke's option, to refund of the purchase price, free of charge repair, or replacement of a defective product which is returned to a Fluke authorized service center within the warranty period.

To obtain warranty service, contact your nearest Fluke authorized service center to obtain return authorization information, then send the product to that service center, with a description of the difficulty, postage and insurance prepaid (FOB Destination). Fluke assumes no risk for damage in transit. Following warranty repair, the product will be returned to Buyer, transportation prepaid (FOB Destination). If Fluke determines that failure was caused by neglect, misuse, contamination, alteration, accident, or abnormal condition of operation or handling, including overvoltage failures caused by use outside the product's specified rating, or normal wear and tear of mechanical components, Fluke will provide an estimate of repair costs and obtain authorization before commencing the work. Following repair, the product will be returned to the Buyer transportation prepaid and the Buyer will be billed for the repair and return transportation charges (FOB Shipping Point).

THIS WARRANTY IS BUYER'S SOLE AND EXCLUSIVE REMEDY AND IS IN LIEU OF ALL OTHER WARRANTIES, EXPRESS OR IMPLIED, INCLUDING BUT NOT LIMITED TO ANY IMPLIED WARRANTY OF MERCHANTABILITY OR FITNESS FOR A PARTICULAR PURPOSE. FLUKE SHALL NOT BE LIABLE FOR ANY SPECIAL, INDIRECT, INCIDENTAL OR CONSEQUENTIAL DAMAGES OR LOSSES, INCLUDING LOSS OF DATA, ARISING FROM ANY CAUSE OR THEORY.

Since some countries or states do not allow limitation of the term of an implied warranty, or exclusion or limitation of incidental or consequential damages, the limitations and exclusions of this warranty may not apply to every buyer. If any provision of this Warranty is held invalid or unenforceable by a court or other decision-maker of competent jurisdiction, such holding will not affect the validity or enforceability of any other provision.

Fluke Corporation
P.O. Box 9090
Everett, WA 98206-9090
U.S.A.

Fluke Europe B.V.
P.O. Box 1186
5602 BD Eindhoven
The Netherlands

Table of Contents

Title	Page
Introduction.....	1
Contact Fluke.....	1
Safety Information.....	2
Symbols.....	4
Hazardous Voltage.....	4
Test Lead Alert.....	4
Specifications.....	5
Detailed Specifications.....	5
AC Voltage.....	5
DC Voltage, Continuity, Resistance, Diode Test, and Capacitance.....	6
AC and DC Current.....	6
Frequency.....	6
Frequency Counter Sensitivity.....	7
Input Characteristics.....	7
MIN MAX Recording.....	7
Required Equipment.....	8
Performance Tests.....	9
Display Test.....	9
Backlight Test.....	9
Keypad Test.....	9
Fuse Test.....	10
Function Performance Tests.....	11
Before Calibration Adjustment.....	14
Enter the Password.....	14
Change the Password.....	14
Restore the Default Password.....	15
Calibration Adjustment.....	16
Maintenance.....	18
User-Replaceable Parts.....	20

List of Tables

Table	Title	Page
1.	Symbols.....	4
2.	Required Equipment.....	8
3.	Performance Tests.....	12
4.	Calibration Adjustment.....	17
5.	User-Replaceable Parts.....	20

List of Figures

Figure	Title	Page
1.	Fuse Test	10
2.	Non-Current Performance Test Connections	11
3.	Current Performance Test Connections	12
4.	Calibration Password Reset.....	15
5.	Battery and Fuse Replacement.....	19
6.	Replacement Parts and Accessories	21

Introduction

Warning

To prevent possible electrical shock, fire, or personal injury, read all safety information before you use the Product.

This manual contains the verification and calibration adjustment procedures for the CNX 3000 Wireless Multimeter (the Product). Please see the *CNX 3000 Users Manual* for usage information.

Contact Fluke

To contact Fluke, call one of the following telephone numbers:

- Technical Support USA: 1-800-44-FLUKE (1-800-443-5853)
- Calibration/Repair USA: 1-888-99-FLUKE (1-888-993-5853)
- Canada: 1-800-36-FLUKE (1-800-363-5853)
- Europe: +31 402-675-200
- Japan: +81-3-6714-3114
- Singapore: +65-6799-5566
- Anywhere in the world: +1-425-446-5500

Or, visit Fluke's website at www.fluke.com.

To register your product, visit <http://register.fluke.com>.

To view, print, or download the latest manual supplement, visit <http://us.fluke.com/usen/support/manuals>.

Safety Information

A **Warning** identifies conditions and procedures that are dangerous to the user. A **Caution** identifies conditions and procedures that can cause damage to the Product or the equipment under test.

Warning

To prevent possible electrical shock, fire, or personal injury:









- Carefully read all instructions.
- Use the Product only as specified, or the protection supplied by the Product can be compromised.
- Limit operation to the specified measurement category, voltage, or amperage ratings.
- Do not use the Product around explosive gas, vapor, or in damp or wet environments.
- Do not touch voltages >30 V ac rms, 42 V ac peak, or 60 V dc.
- Do not exceed the Measurement Category (CAT) rating of the lowest rated individual component of a Product, probe, or accessory.
- Measure a known voltage first to make sure that the Product operates correctly.
- Do not use, and disable the Product if it is damaged.
- Do not work alone.
- Disconnect power and discharge all high-voltage capacitors before you measure resistance, continuity, capacitance, or a diode junction.
- Comply with local and national safety codes. Use personal protective equipment (approved rubber gloves, face protection, and flame-resistant clothes) to prevent shock and arc blast injury where hazardous live conductors are exposed.
- Remove circuit power before you connect the Product in the circuit when you measure current. Connect the Product in series with the circuit.
- Limit operation to the specified measurement category, voltage, or amperage ratings.
- Have an approved technician repair the Product.
- Do not operate the Product with covers removed or the case open. Hazardous voltage exposure is possible.
- Use only specified replacement parts.
- Remove the input signals before you clean the Product.
- Replace the batteries when the low battery indicator shows to prevent incorrect measurements.
- The battery door must be closed and locked before you operate the Product.
- Remove the test leads and all input signals before you replace the batteries or fuses.
- Do not use the Product if it operates incorrectly.

- **Examine the case before you use the Product. Look for cracks or missing plastic. Carefully look at the insulation around the terminals.**
- **Use only correct measurement category (CAT), voltage, and amperage rated probes, test leads, and adapters for the measurement.**
- **Do not use test leads if they are damaged. Examine the test leads for damaged insulation, exposed metal, or if the wear indicator shows. Check test lead continuity.**
- **Keep fingers behind the finger guards on the probes.**
- **Do not touch the probes to a voltage source when the test leads are connected to the current terminals.**
- **Replace a blown fuse with exact replacement only for continued protection against arc flash.**
- **Remove the batteries if the Product is not used for an extended period of time, or if stored in temperatures above 50 °C. If the batteries are not removed, battery leakage can damage the Product.**
- **Batteries contain hazardous chemicals that can cause burns or explode. If exposure to chemicals occurs, clean with water and get medical aid.**
- **Connect the common test lead before the live test lead and remove the live test lead before the common test lead.**
- **Remove all probes, test leads, and accessories that are not necessary for the measurement.**
- **Do not use the TL175 or TP175 test probes in CAT III or CAT IV environments without the probe tip fully extended and correct category rating visible in the window.**
- **When the TL175 is used with instruments or other accessories, the lowest category rating of the combination applies. One exception is when the probe is used with the AC172 or AC175.**
- **Make sure test leads are firmly connected to instrument and other accessories.**

Symbols

The symbols in Table 1 are used on the Product or in this manual.

Table 1. Symbols

Symbol	Meaning
	Risk of Danger. Important information. See Manual.
	Conforms to European Union directives.
	Conforms to relevant North American Safety Standards.
	Battery
	Hazardous voltage.
	Conforms to relevant Australian EMC requirements.
	Fuse
CAT II	Measurement Category II is applicable to test and measuring circuits connected directly to utilization points of low voltage mains installation.
CAT III	Measurement Category III is applicable to test and measuring circuits connected to the distribution part of the building's low-voltage MAINS installation.
CAT IV	Measurement Category IV is applicable to test and measuring circuits connected at the source of the building's low-voltage MAINS installation.
	Double Insulation
	This product complies with the WEEE Directive (2002/96/EC) marking requirements. The affixed label indicates that you must not discard this electrical/electronic product in domestic household waste. Product Category: With reference to the equipment types in the WEEE Directive Annex I, this product is classed as category 9 "Monitoring and Control Instrumentation" product. Do not dispose of this product as unsorted municipal waste. Go to Fluke's website for recycling information.

Hazardous Voltage

The display shows ⚡ and the hazardous voltage indicator illuminates red when a hazardous voltage (≥ 30 V) is present on the input of the Product

Test Lead Alert

The display shows LEAD for a second when you turn the function switch to or from the mA position to remind you to make sure the test leads are in the correct terminals.

Specifications

Maximum voltage between any Terminal and Earth Ground: 1000 V dc or ac rms

△ Fuse Protection for mA inputs 0.44 A (44/100 A, 440 mA), 1000 V FAST Fuse, Fluke specified part only

Display (LCD)

Update rate 4/sec
 Volts, amps, ohms, 6000 counts
 Frequency 10,000 counts
 Capacitance 1,000 counts

Battery Type Three AA Alkaline batteries, NEDA 15A IEC LR6

Battery Life 250 hours minimum

Temperature

Operating -10 °C to 50 °C
 Storage -40 °C to 60 °C

Relative Humidity 0 % to 90 % (0 °C to 35 °C), 0 % to 75 % (35 °C to 40 °C), 0 % to 45 % (40 °C to 50 °C)

Altitude

Operating 2,000 m
 Storage 12,000 m

Temperature Coefficient 0.1 X (specified accuracy) /°C (<18 °C or >28 °C)

Wireless Frequency 2.4 GHz ISM Band 20 meter range

Size (HxWxL) 1.87 in x 3.68 in x 8.14 in (4.75 cm x 9.3 cm x 20.7 cm)

Weight 17.2 oz (487.5 g)

Radio Frequency Certification FWCS IC:6627A

Safety IEC 61010-1, 600 V CAT IV / 1000 V CAT III, Pollution Degree 2.

Electromagnetic Environment IEC 61236-1, Portable

Electromagnetic Compatibility Applies to use in Korea only. Class A Equipment (Industrial Broadcasting & Communication Equipment) ^[1]

[1] This product meets requirements for industrial (Class A) electromagnetic wave equipment and the seller or user should take notice of it. This equipment is intended for use in business environments and is not to be used in homes.

Detailed Specifications

For all specifications:

Accuracy is specified for 1 year after calibration, at operating temperatures of 18 °C to 28 °C, with relative humidity at 0 % to 90 %. Accuracy specifications take the form of $\pm([\% \text{ of Reading}] + [\text{Number of least significant digits}])$.

AC Voltage

Range ^[1]	Resolution	Accuracy ^{[2][3][4]}	
		45 Hz to 500 Hz	500 Hz to 1 kHz
600.0 mV	0.1 mV	1.0 % + 3	2.0 % + 3
6.000 V	0.001 V		
60.00 V	0.01 V		
600.0 V	0.1 V		
1000 V	1 V		
<p>[1] All ac voltage ranges are specified from 1 % of range to 100 % of range.</p> <p>[2] Crest factor of ≤ 3 at 4000 counts, decreasing linearly to 1.5 at full scale.</p> <p>[3] For non-sinusoidal waveforms, add $-(2 \% \text{ of reading} + 2 \% \text{ full scale})$ typical, for crest factor up to 3.</p> <p>[4] Do not exceed 10^7 V-Hz</p>			

DC Voltage, Continuity, Resistance, Diode Test, and Capacitance

Function	Range	Resolution	Accuracy
$\overline{\text{mV}}$	600.0 mV	0.1 mV	0.09 % + 2
$\overline{\text{V}}$	6.000 V	0.001 V	0.09 % + 2
	60.00 V	0.01 V	
	600.0 V	0.1 V	
	1000 V	1 V	0.15 % + 2
$\text{ })$	600 Ω	1 Ω	Meter beeps at <25 Ω , beeper detects opens or shorts of 250 μs or longer.
Ω	600.0 Ω	0.1 Ω	0.5 % + 2
	6.000 k Ω	0.001 k Ω	0.5 % + 1
	60.00 k Ω	0.01 k Ω	
	600.0 k Ω	0.1 k Ω	
	600.0 k Ω	0.001 M Ω	
	50.00 M Ω	0.01 M Ω	1.5 % + 3
Diode Test	2.000 V	0.001 V	1 % + 2
⎓	1000 nF	1 nF	1.2 % + 2
	10.00 μF	0.01 μF	
	100.0 μF	0.1 μF	
	9999 μF ^[1]	1 μF	10 % typical

[1] In the 9999 μF range for measurements to 1000 μF , the measurement accuracy is 1.2 % + 2.

AC and DC Current

Function	Range ^[1]	Resolution	Accuracy
$\widehat{\text{mA}}$ (45 Hz to 1 kHz)	60.00 mA	0.01 mA	1.5 % + 3
	400.0 mA ^[3]	0.1 mA	
mA_{DC} ^[2]	60.00 mA	0.01 mA	0.5 % + 3
	400.0 mA ^[3]	0.1 mA	

[1] All ac current ranges are specified from 5 % of range to 100 % of range.
 [2] Input burden voltage (typical): 400 mA input 2 mV/mA.
 [3] 400.0 mA accuracy specified up to 600 mA overload.

Frequency

Range	Resolution	Accuracy ^[1]
99.99 Hz	0.01 Hz	0.1 % + 1
999.9 Hz	0.1 Hz	
9.999 kHz	0.001 kHz	
99.99 kHz	0.01 kHz	

[1] Frequency is specified up to 99.99 kHz in volts and up to 10 kHz in amps.

Frequency Counter Sensitivity

Input Range ^{[1][2]}		Typical Sensitivity (RMS Sine Wave)				
		2 Hz to 45 Hz	45 Hz to 10 kHz	10 kHz to 20 kHz	20 kHz to 50 kHz	50 kHz to 100 kHz
\tilde{V}	6 V	0.5 V	0.6 V	1.0 V	2.8 V	Unspecified ^[3]
	60 V	5 V	3.8 V	4.1 V	5.6 V	9.6 V
	600 V	50 V	36 V	39 V	50 V	58 V
	1000 V	500 V	300 V	320 V	380 V	NA
$\overline{\tilde{V}}$	6 V	0.5 V	0.75 V	1.4 V	4.0 V	Unspecified ^[3]
	60 V	4 V	3.8 V	4.3 V	6.6 V	13 V
	600 V	40 V	36 V	39 V	45 V	58 V
	1000 V	500 V	300 V	320 V	380 V	NA
\tilde{mA}	60.00 mA	5 mA	4 mA	NA	NA	NA
	400.0 mA	5 mA	4 mA	NA	NA	NA

[1] Maximum input for specified accuracy = 10X Range or 1000 V.
 [2] Noise at low frequency and amplitude may exceed the frequency accuracy specification.
 [3] Unspecified but usable depending on quality and amplitude of signal.
 [4] In mA and A ranges, frequency measurement is specified to 10 kHz.

Input Characteristics

Function	Overload Protection	Input Impedance (nominal)	Common Mode Rejection Ratio (1 k Ω unbalance)		Normal Mode Rejection
$\overline{\tilde{V}}$	1100 V rms	>10 M Ω <100 pF	> 120 dB at dc, 50 Hz or 60 Hz		> 60 dB at 50 Hz or 60 Hz
\tilde{V}	1100 V rms	>10 M Ω < 100 pF	> 60 dB, dc to 60 Hz		
$\overline{\tilde{mA}}$	1100 V rms	>10 M Ω <100 pF	> 120 dB at dc, 50 Hz or 60 Hz		> 60 dB at 50 Hz or 60 Hz
		Open Circuit Test Voltage	Full Scale Voltage		Typical Short Circuit Current
			To 6 M Ω	50 M Ω	
Ω / \rightarrow	1100 V rms	<2.7 V dc	<0.7 V dc	<0.9 V dc	<350 μ A
$\overline{\tilde{V}}$ / \rightarrow	1100 V rms	<2.7 V dc	2.000 V dc		<1.1 mA
Function	Overload Protection		Overload		
mA	Fused, 44/100 A, 1000 V FAST Fuse		600 mA overload for 2 minutes maximum, 10 minutes rest minimum		

MIN MAX Recording

Function	Accuracy
DC Functions	The specified accuracy of the measurement function ± 12 counts for changes >350 ms in duration.
AC Functions	The specified accuracy of the measurement function ± 40 counts for changes >900 ms in duration.

Required Equipment

The equipment in Table 2 is necessary for performance tests and calibration adjustment.

Table 2. Required Equipment

Recommended Equipment	Measurement Function	Accuracy
5500A Multi-Product Calibrator (or equivalent)	DC Volts	10 mV to 600 V ±0.125 %
	DC Current	600 µA to 10 A ±0.25 %
	AC Volts	6 mV to 600 V ±0.25 % @ 45 Hz to 1 kHz
	AC Current	600 µA to 10 A ±0.375 % @ 45 Hz to 1 kHz
	Resistance	0 Ω to 5 MΩ ±0.225 % 10 Ω to 30 MΩ ±0.375 %
	Capacitance	9 µF to 900 µF ±0.475 %
5500A Multi-product Calibrator (or equivalent)	Frequency	2 V @ 50 kHz ±0.025 %

Performance Tests

⚠⚠ Warning

To prevent possible electrical shock, fire, or personal injury, do not perform the performance test procedures unless the Product is fully assembled.

The performance tests verify the full operation of the Product and measure the accuracy of each function against Product specifications. If the Product fails a part of the test, calibration adjustment and/or repair is necessary. See “Calibration Adjustment”.

Display Test

To verify that all segments of the display function:

1. Turn on the Product.
2. Look at the icons on the display to make sure there are no missing segments or voids in the display text.
3. If segments of the display are missing, repair is necessary. See “Contact Fluke”.

Backlight Test

To verify that the backlight functions:

1. With the Product on, push .
2. The backlight comes on. If it does not, repair is necessary. See “Contact Fluke”.

Keypad Test

To verify that the keypad functions, turn on the Product and push each button separately. Each time a button is pushed, the Product will beep. If the Product does not act as described here, see “Contact Fluke”.

Fuse Test

To verify that the Product fuse is good:

1. Set the function switch to $\frac{+}{\Omega}$.
2. Connect a test lead to the $\frac{+}{V_{\Omega}}$ jack as shown in Figure 1.
3. Touch the other end of the test lead to the mA jack.

A good fuse will show a resistance of 12Ω or less. Replace the fuse if the resistance is higher or **OL** is shown. See the “User-Replaceable Parts” section for the correct replacement fuse.

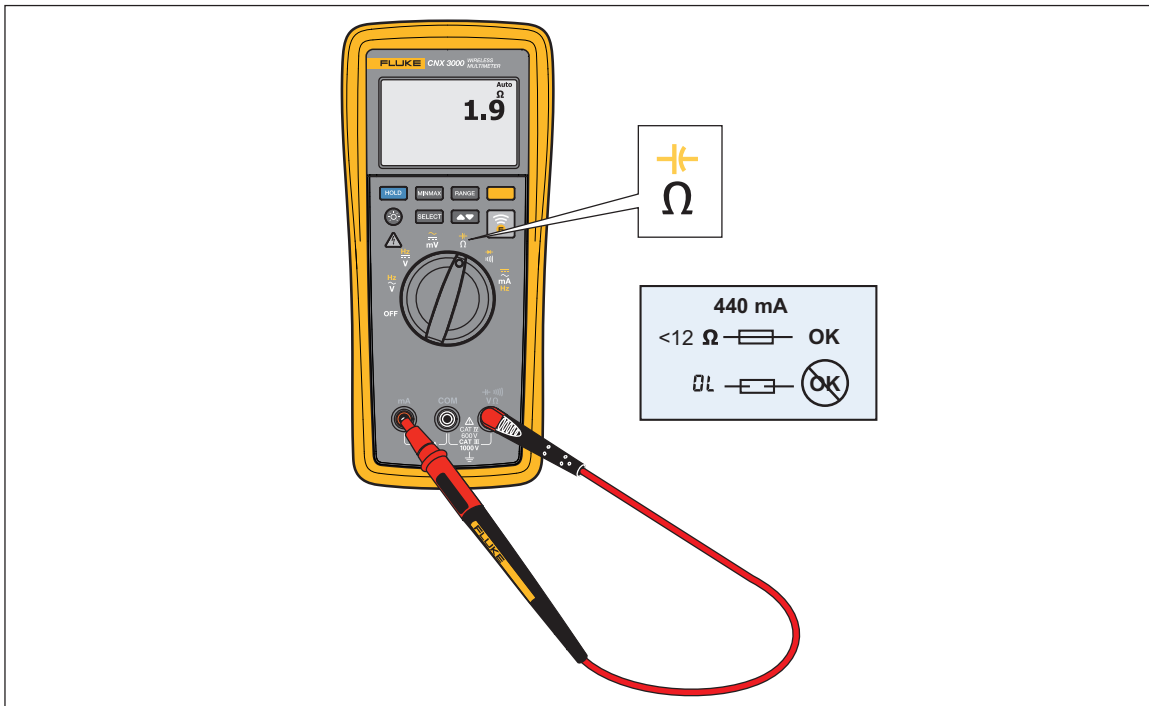

Figure 1. Fuse Test

gxr009.eps

Function Performance Tests

Before you do the function performance tests:

1. Make sure that you have the necessary equipment. See Table 2.
2. Make sure the Product battery is good or replace it if necessary. See “Battery Replacement”.
3. Warm up the Calibrator as necessary. Refer to its specifications.
4. Let the temperature of the UUT (Unit Under Test) become stable to room temperature.

For the non-current tests, see the connections in Figure 2. For the current tests, see the connections in Figure 3:

1. Apply the input level for each step shown in Table 3.
2. Compare the indication on the Product display with the display reading limits in Table 3.
3. If the display indication falls outside of the range shown in Table 3, calibration adjustment or repair of the Product is necessary. See “Calibration Adjustment”.

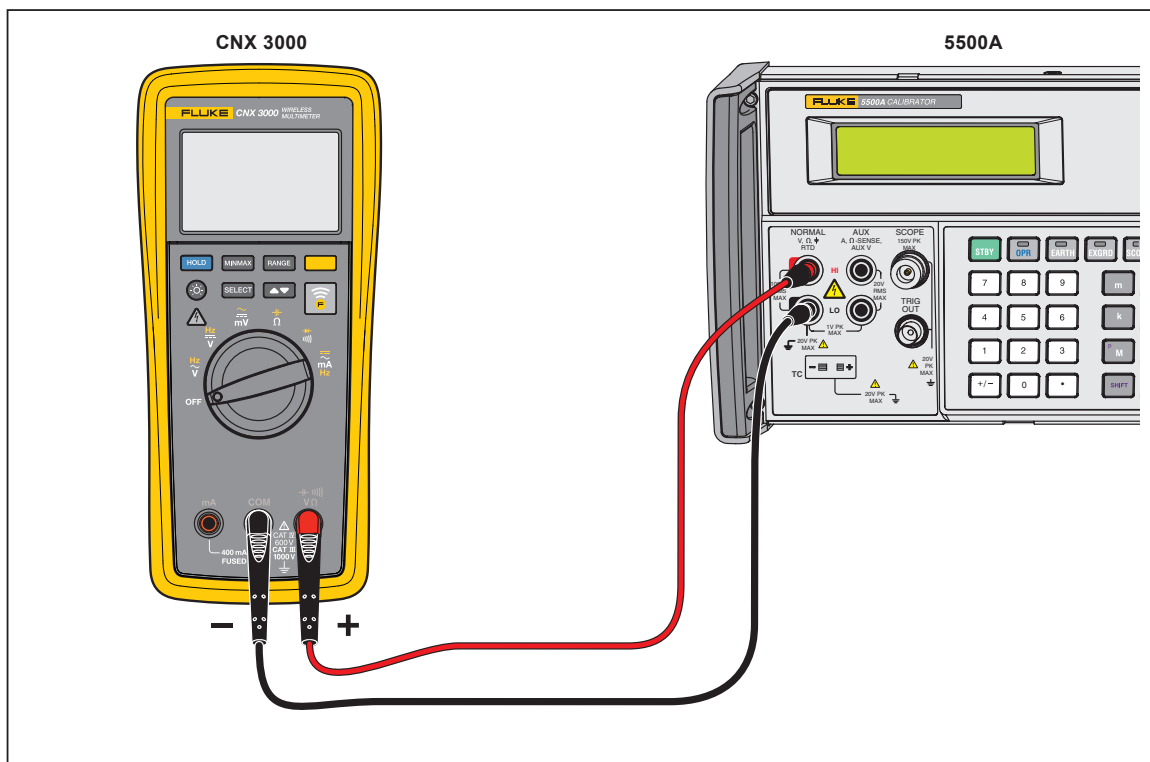

Figure 2. Non-Current Performance Test Connections

hcd07.eps

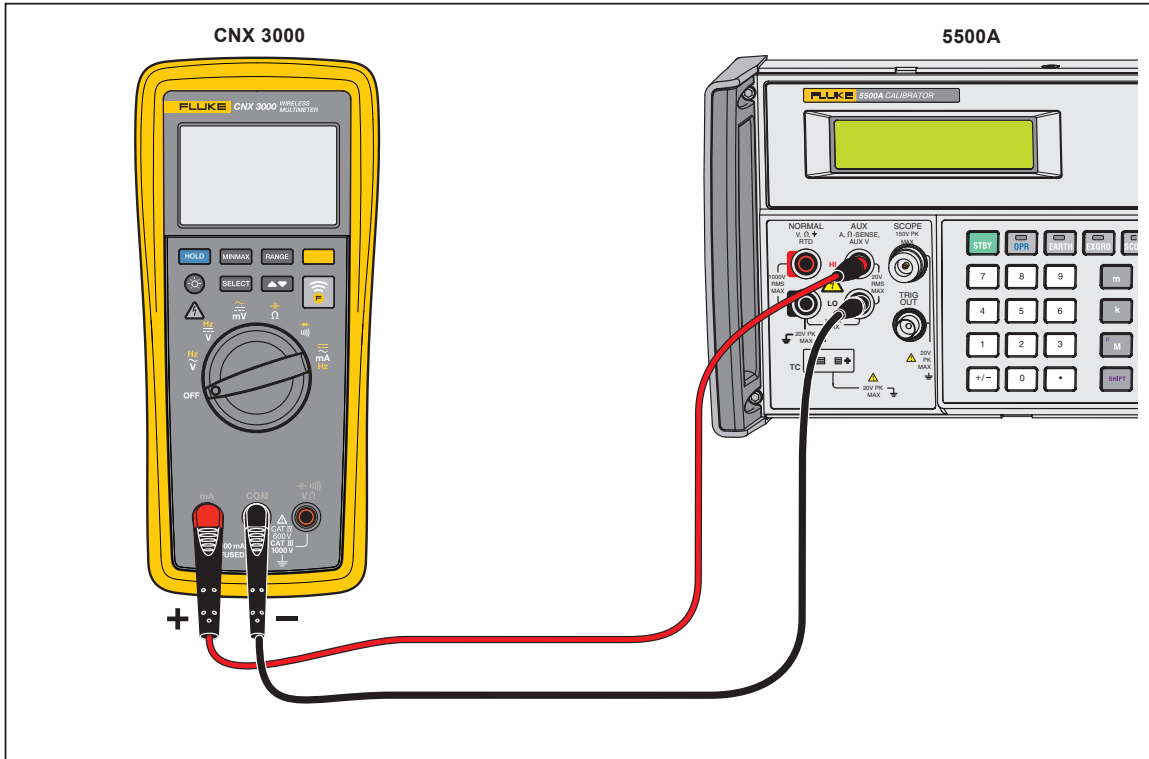











Figure 3. Current Performance Test Connections

hcd09.eps

Table 3. Performance Tests

Test (Switch Position)	Input	Lower Limit	Upper Limit	Units
$\frac{\text{Hz}}{\text{V}}$ Volts AC	300 mV 60 Hz	296.7	303.3	mV ac
	5 V 60 Hz	4.947	5.053	V ac
	5 V 1 kHz	4.897	5.103	
	3 V 60 Hz	2.967	3.033	
	50 V 60 Hz	49.47	50.53	
	50 V 1 KHz	48.97	51.03	
	30 V 60 Hz	29.67	30.33	
	500 V 60 Hz	494.7	505.3	
	500 V 1 kHz	489.7	510.3	
	1000 V 60 Hz	987	1013	
$\frac{\text{Hz}}{\text{V}}$ Volts AC, Frequency	1 V 900 Hz	899.0	901.0	Hz
	5 V 50 kHz	49.94	50.06	

Table 3. Performance Tests (cont.)

Test (Switch Position)	Input	Lower Limit	Upper Limit	Units
 DC Volts	.01 V	0.008	0.012	V dc
	-5 V	-5.006	-4.994	
	50 V	49.94	50.06	
	10 V	9.7	10.3	
	-500 V	-500.6	-499.4	
	1000 V	997	1003	
 DC Millivolts	3 mV	2.8	3.2	mV dc
	500 mV	499.4	500.6	V dc
	-500 mV	-500.6	-499.4	
 AC Millivolts	30 mV 60 Hz	29.4	30.6	mV ac
	500 mV 60 Hz	494.7	505.3	
	500 mV 1 kHz	489.7	510.3	
 Ohms	6 Ω	5.8	6.2	Ω
	500 Ω	497.3	502.7	
	.6 kΩ	.596	.604	kΩ
	5 kΩ	4.974	5.026	
	50 kΩ	49.74	50.26	
	500 kΩ	497.4	502.6	
	5 MΩ	4.974	5.026	MΩ
50 MΩ	49.22	50.78		
 Capacitance	10 nF	8	12	nF
	900 nF	887	913	
	9 μF	8.87	9.13	μF
	90 μF	88.7	91.3	
	900 μF	887	913	
 Continuity	24 Ω	Beeper On		
	251 Ω	Beeper Off		
 Diode	1.95 V	1.928	1.972	V dc
 mA AC	50 mA 60 Hz	49.22	50.78	mA ac
	350 mA 1 kHz	344.4	355.6	
 DC Amps	50 mA	49.72	50.28	mA dc
	350 mA	347.9	352.1	

Before Calibration Adjustment

Before the Product calibration can be adjusted, you must put the Product into its Calibration mode menu and enter your password.

To get to Calibration mode:

1. With the Product off, push and hold **HOLD**.
2. Turn the knob to $\frac{*}{\Omega}$. **CAL** is shown. The Product is now in Calibration mode.

Enter the Password

To enter the password:

1. Push . The Calibration counter is shown, for example: **N002**.
2. Push . The display shows “????”. The factory default password that must be entered is “**1234**”.
3. The top row of buttons corresponds to each number:
 - Push **HOLD** to enter a 1.
 - Push **MINMAX** to enter a 2.
 - Push **RANGE** to enter a 3.
 - Push to enter a 4.
 - Push  to enter a 5.

As each number is entered, the cursor automatically moves to the next number.

To enter “**1234**”, push **HOLD**, **MINMAX**, **RANGE**, and .

4. Push to go to the first calibration point **C-01**.

If the correct password is entered, “**C-01**” is shown. If the incorrect password is entered, “????” is shown and the password must be entered correctly to go to the first calibration point, “**C-01**”.

Change the Password

Note

If you change the password and then lose it, see the “Restore the Default Password” section.

To change the password:

1. Push . The Calibration counter is shown, for example: **N002**.
2. Push . The display shows “????”.
3. Enter the correct password digits.
4. Push **RANGE**. “----” is shown.
5. Enter the new password digits.
6. Push to enter and store the new password.



static awareness



A Message From
Fluke Corporation

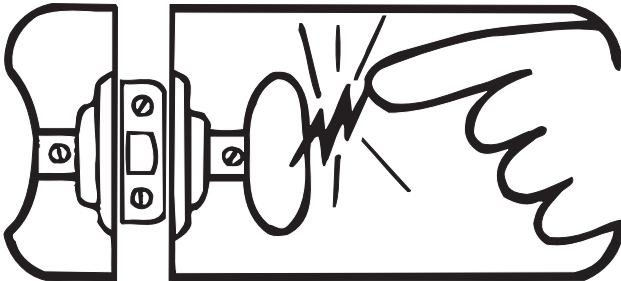

Some semiconductors and custom IC's can be damaged by electrostatic discharge during handling. This notice explains how you can minimize the chances of destroying such devices by:

1. Knowing that there is a problem.
2. Learning the guidelines for handling them.
3. Using the procedures, packaging, and bench techniques that are recommended.

The following practices should be followed to minimize damage to S.S. (static sensitive) devices.

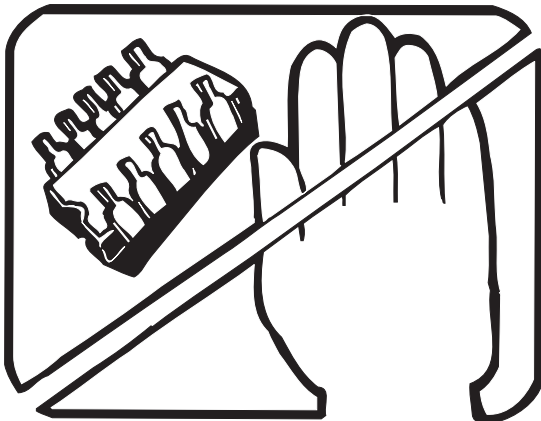

1. MINIMIZE HANDLING

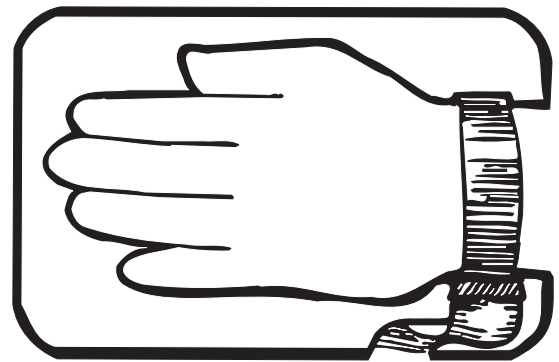

3. DISCHARGE PERSONAL STATIC BEFORE HANDLING DEVICES. USE A HIGH RESISTANCE GROUNDING WRIST STRAP.

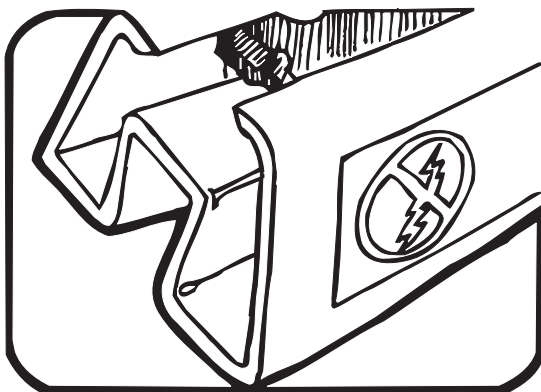

2. KEEP PARTS IN ORIGINAL CONTAINERS UNTIL READY FOR USE.

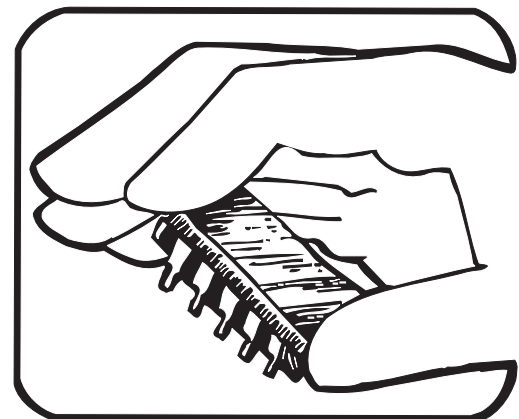

4. HANDLE S.S. DEVICES BY THE BODY.

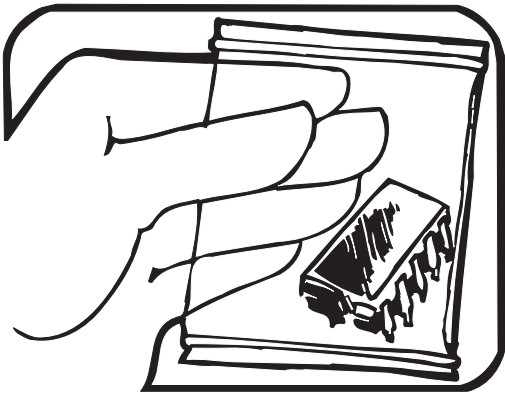

5. USE STATIC SHIELDING CONTAINERS FOR HANDLING AND TRANSPORT.

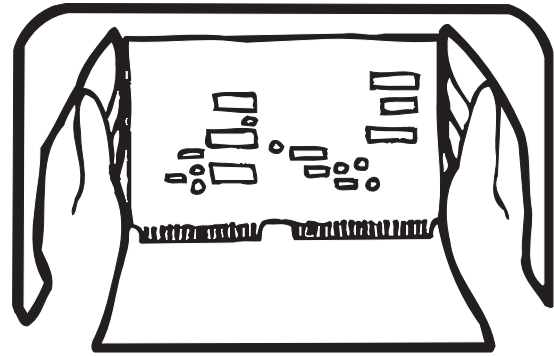

8. WHEN REMOVING PLUG-IN ASSEMBLIES HANDLE ONLY BY NON-CONDUCTIVE EDGES AND NEVER TOUCH OPEN EDGE CONNECTOR EXCEPT AT STATIC-FREE WORK STATION. PLACING SHORTING STRIPS ON EDGE CONNECTOR HELPS PROTECT INSTALLED S.S. DEVICES.

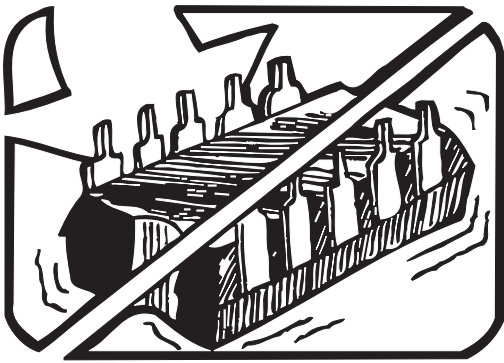

6. DO NOT SLIDE S.S. DEVICES OVER ANY SURFACE.

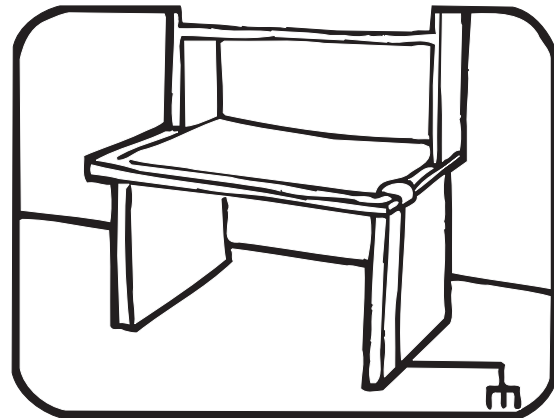

9. HANDLE S.S. DEVICES ONLY AT A STATIC-FREE WORK STATION.

10. ONLY ANTI-STATIC TYPE SOLDER-SUCKERS SHOULD BE USED.

11. ONLY GROUNDED-TIP SOLDERING IRONS SHOULD BE USED.

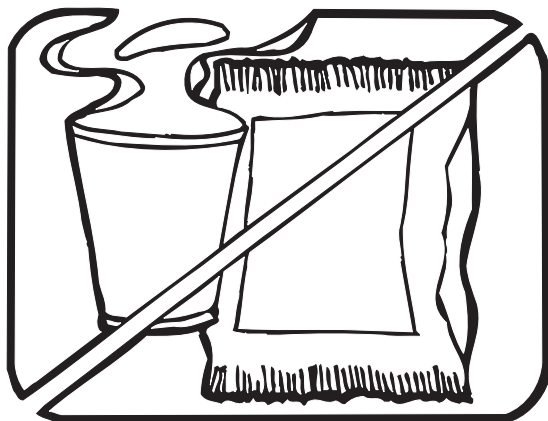

7. AVOID PLASTIC, VINYL AND STYROFOAM® IN WORK AREA.

PORTIONS REPRINTED
WITH PERMISSION FROM TEKTRONIX INC.
AND GERNER DYNAMICS, POMONA DIV.

Restore the Default Password

If the calibration password is lost, the default password (1234) can be manually restored with the subsequent steps:

⚠️⚠️ Warning

To prevent electric shock or personal injury, remove all input signals before you open the Product.

1. Remove the Product battery door. See “Battery Replacement”.
2. With a Phillips screwdriver, remove the bottom case screws.
3. Keep the pca in the top case.
4. Apply 4.5 V dc across the battery contacts on the pca. Note the polarity that is shown in Figure 4.
5. Turn the knob on the front of the Product to turn on the Product.
6. Short across the CAL keypad on the pca. See Figure 4. The default password is now restored.
7. Remove the 4.5 V dc supply and replace the bottom case, batteries, and battery door.

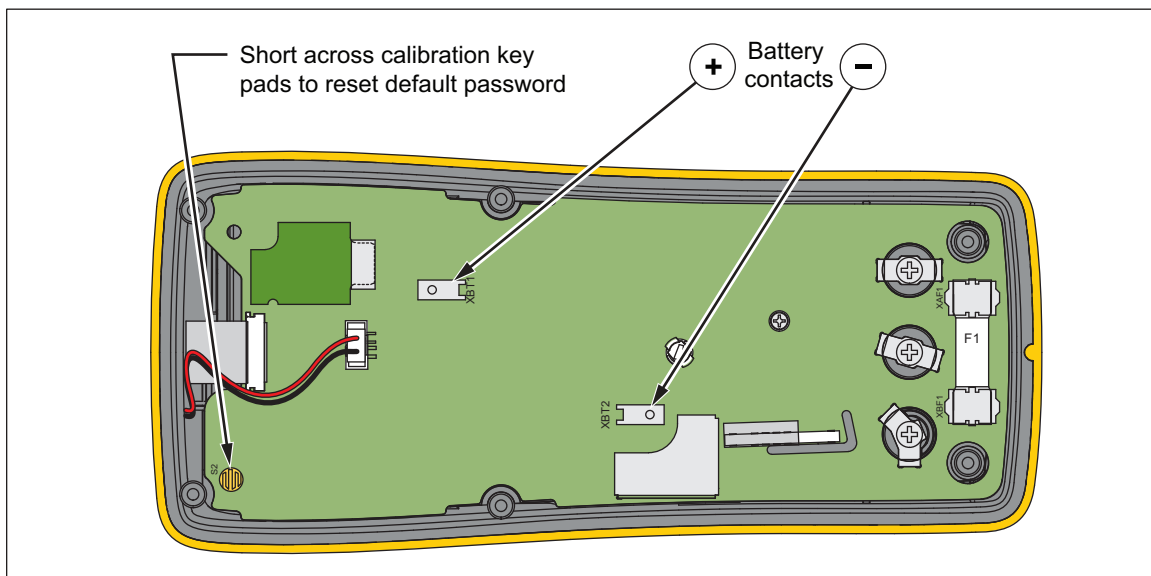

Figure 4. Calibration Password Reset

hcd08.eps

Calibration Adjustment

The Product features closed-case calibration adjustment and uses known reference sources. The Product measures the applied reference source, calculates correction factors, and stores the correction factors in nonvolatile memory.

Should the Product fail any of the performance tests, do the calibration adjustment procedure.

When “C-01” is shown on the display, apply the correct input signal shown in Table 4 to the Product. Then push to confirm the calibration step. If the input signal does not satisfy the calibration requirement, “Err” is shown. If the signal is not stable, it can be necessary to push several times to confirm the calibration.

After confirmation, the Product goes to the subsequent calibration step.

Note

After you push , wait until the calibration step number advances before you change the calibrator source. Some adjustment steps can take several seconds to execute before the Product goes to the subsequent step.

Set the Calibrator to Standby after you complete adjustment of each function.

Warning

To prevent possible electrical shock, fire, or personal injury:







Do not change source value until calibration step number on the display has incremented.

Input each signal to the Product in the sequence shown in Table 4. When the last calibration point is recorded, “End” shows on the display.

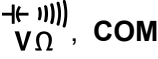
Note

*While the calibration adjustment points are shown in Table 4, the Product also can show the necessary inputs. For each step, push **MINMAX** to see the necessary input and then push **HOLD** to see the measured value.*

Table 4. Calibration Adjustment

Calibration Step	Switch Position	Jacks	Calibrator Output Signal	
C-01	 mV	 V Ω , COM	0 V dc	
C-02			300 mV dc	
C-03			60 mV dc	
C-04			-300 mV dc	
C-05	 Hz V		6 V dc	
C-06			60 V dc	
C-07			600 V dc	
C-08	 Hz V		60 V ac @ 60 Hz	
C-09	 Ω		600 Ω	
C-10			6 k Ω	
C-11			60 k Ω	
C-12			600 k Ω	
C-13			6 M Ω	
C-14	 2 V dc		2 V dc	
C-15	 mA Hz		mA, COM	400 mA dc
C-16				60 mA ac @ 60 Hz

Maintenance

Warning

To prevent a possible electrical shock or personal injury:

- Have an approved technician repair the Product.
- Do not operate the Product with covers removed or the case open. Hazardous voltage exposure is possible.
- Use only specified replacement parts.
- Remove the input signals before you clean the Product.

Clean the case with a damp cloth and weak detergent. Do not use a solvent or cleaners with abrasives.

Dirt or moisture in the terminals can cause incorrect measurements. To clean the terminals:

1. Turn off the Product and remove all test leads.
2. Shake out dirt that can possibly be in the terminals.
3. Soak a clean swab with weak detergent and water.
4. Move the swab around in each terminal.
5. Dry each terminal with canned air to push the water and detergent out of the terminals.

Warning

To prevent electrical shock or personal injury, remove the test leads and all input signals before you replace the batteries or fuses. To prevent damage or injury, install only specified replacement parts shown in Table 5.

Warning

To prevent possible electrical shock, fire, or personal injury:

- Replace a blown fuse with exact replacement only for continued protection against arc flash.
- Use only specified replacement fuses.
- Remove the batteries if the Product is not used for an extended period of time, or if stored in temperatures above 50 °C. If the batteries are not removed, battery leakage can damage the Product.
- Repair the Product before use if the battery leaks.
- Be sure that the battery polarity is correct to prevent battery leakage.
- Batteries contain hazardous chemicals that can cause burns or explode. If exposure to chemicals occurs, clean with water and get medical aid.

To replace the batteries:

1. Turn off the Product and remove all test leads.
2. Lift the tilt stand up as shown in Figure 5.
3. Turn the battery-door latch until the unlock symbol (🔓) aligns with the arrow.
4. Lift off the battery door.
5. Remove the three AA batteries and replace them with new ones. Use the correct battery orientation.
6. Install the battery door.
7. Turn the battery-door latch until the locked symbol (🔒) aligns with the arrow.

To replace the fuse:

1. Turn off the Product and remove all test leads.
2. As shown in Figure 5, remove six screws from the case bottom.
3. Pull the case bottom from the case top.
4. Remove the fuse from its holder and replace it with a 440 mA, 1000 V FAST fuse with a minimum interrupt rating of 10,000 A. Use only Fluke PN 943121.
5. To reassemble the Product, do the steps in the opposite sequence.

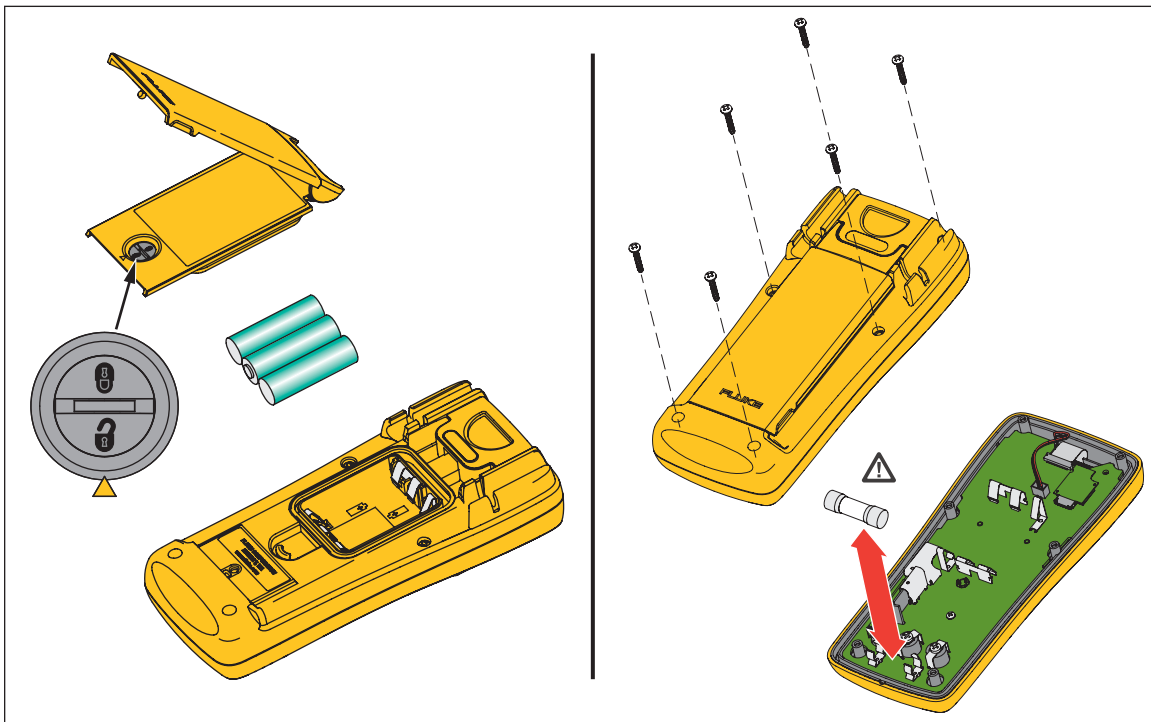



Figure 5. Battery and Fuse Replacement

gxr010.eps

User-Replaceable Parts

If the Product fails, replace the batteries and do a fuse test. User-replaceable parts are shown in Table 5 and Figure 6. To get parts and accessories, see the “Contact Fluke” section.

Table 5. User-Replaceable Parts

Reference Designator	Description	Fluke Part Number	Quantity
F1	 Fuse, 440 mA, 1000 V	943121	1
H1, H2, H3	SCREW,M3-0.5X5MM,PHILLIPS PAN HEAD,DIN 7985,STEEL,ZINC,METRIC MACHINE SCREW	3498942	3
H4	SCREW,4-14,.312,PAN,PHILLIPS,STEEL,ZINC-CLEAR,THD FORM,#3 HEAD	642931	1
MP15	FLUKE-3000-2002,CASE BOTTOM	4121881	1
MP16	FLUKE 89-4-8012,BATTERY CONTACT, DUAL	666435	2
BT1, BT2, BT3	BATTERY,PRIMARY,ZN-MNO2,1.5V, 2.24AH,15A,LR6, ALKALINE, AA,14X50MM, BULK	376756	3
MP18	FLUKE-3000-2013, FOAM PAD	4145833	1
MP19	FLUKE-3000-2011,GASKET, BATTERY DOOR	4137532	1
MP20, MP22	FLUKE-3000-2018,BATTERY DOOR ASSEMBLY	4207624	1
MP23	FLUKE-15X7-8013,FASTENER,HALF TURN	2278155	1
H5, H6, H7, H8, H9, H10	SCREW,5-14,.750,PAN,PHILLIPS,STEEL,BLACK CHROMATE,THD FORMING	832246	6
-	FLUKE-28II EX-8007,FOAM PAD,ADHESIVE, 28-2EX	4067356	1 Not Shown
-	4MM ADAPTER,2 PER BAG, 4MM ADAPTER	4004616	1 set Not Shown
-	CNX 3000 DMM Quick Reference Guide	4231002	1
-	CNX 3000 DMM Safety Information	4231677	1
 To ensure safety, use exact replacement only.			

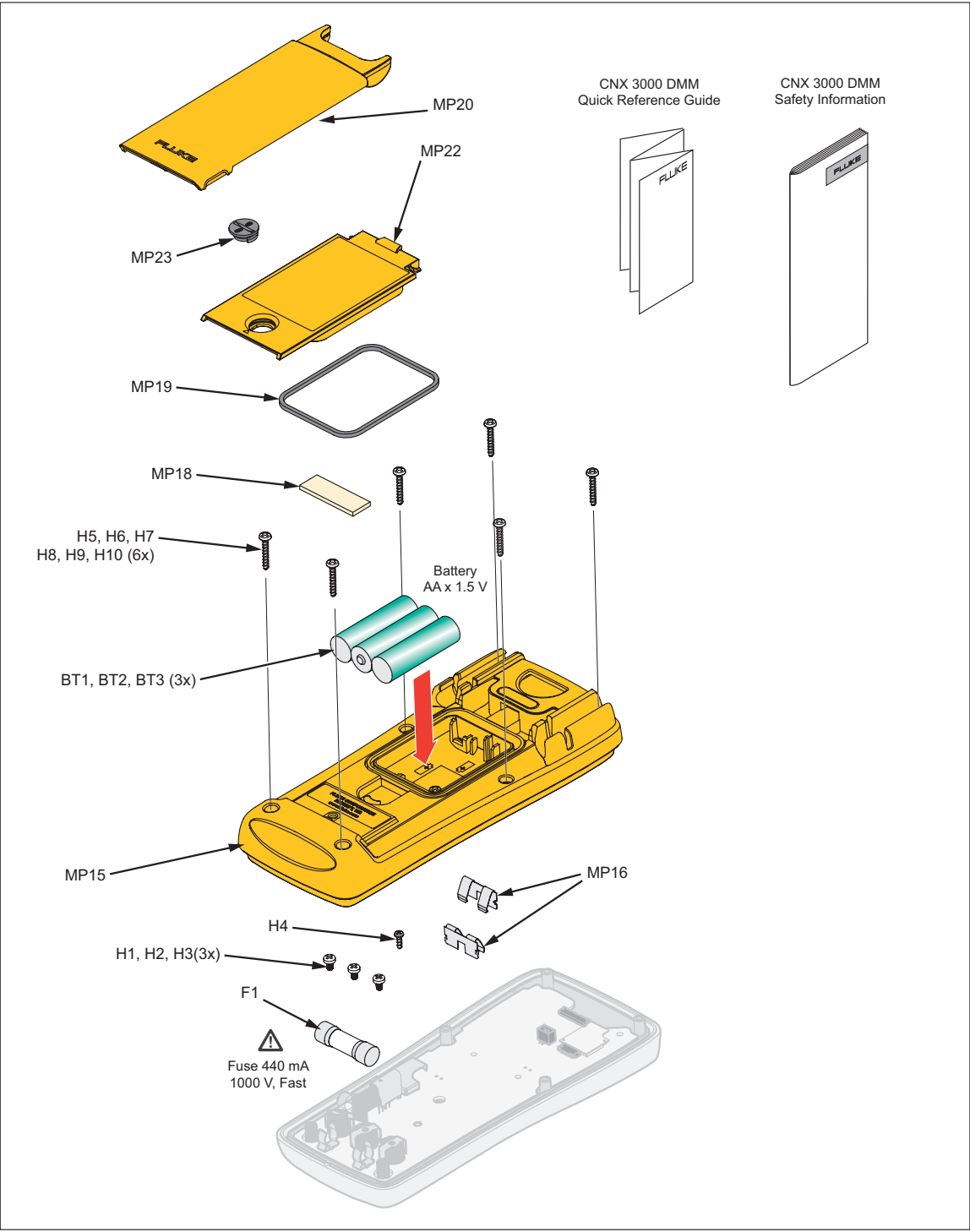

Figure 6. Replacement Parts and Accessories

gxr012.eps

