

Ti90, Ti95
Ti100, Ti105, Ti110, Ti125
TiR105, TiR110, TiR125
Performance Series Thermal Imagers

Users Manual

LIMITED WARRANTY AND LIMITATION OF LIABILITY

Each Fluke product is warranted to be free from defects in material and workmanship under normal use and service. The warranty period is two years and begins on the date of shipment. Parts, product repairs, and services are warranted for 90 days. This warranty extends only to the original buyer or end-user customer of a Fluke authorized reseller, and does not apply to fuses, disposable batteries, or to any product which, in Fluke's opinion, has been misused, altered, neglected, contaminated, or damaged by accident or abnormal conditions of operation or handling. Fluke warrants that software will operate substantially in accordance with its functional specifications for 90 days and that it has been properly recorded on non-defective media. Fluke does not warrant that software will be error free or operate without interruption.

Fluke authorized resellers shall extend this warranty on new and unused products to end-user customers only but have no authority to extend a greater or different warranty on behalf of Fluke. Warranty support is available only if product is purchased through a Fluke authorized sales outlet or Buyer has paid the applicable international price. Fluke reserves the right to invoice Buyer for importation costs of repair/replacement parts when product purchased in one country is submitted for repair in another country.

Fluke's warranty obligation is limited, at Fluke's option, to refund of the purchase price, free of charge repair, or replacement of a defective product which is returned to a Fluke authorized service center within the warranty period.

To obtain warranty service, contact your nearest Fluke authorized service center to obtain return authorization information, then send the product to that service center, with a description of the difficulty, postage and insurance prepaid (FOB Destination). Fluke assumes no risk for damage in transit. Following warranty repair, the product will be returned to Buyer, transportation prepaid (FOB Destination). If Fluke determines that failure was caused by neglect, misuse, contamination, alteration, accident, or abnormal condition of operation or handling, including overvoltage failures caused by use outside the product's specified rating, or normal wear and tear of mechanical components, Fluke will provide an estimate of repair costs and obtain authorization before commencing the work. Following repair, the product will be returned to the Buyer transportation prepaid and the Buyer will be billed for the repair and return transportation charges (FOB Shipping Point).

THIS WARRANTY IS BUYER'S SOLE AND EXCLUSIVE REMEDY AND IS IN LIEU OF ALL OTHER WARRANTIES, EXPRESS OR IMPLIED, INCLUDING BUT NOT LIMITED TO ANY IMPLIED WARRANTY OF MERCHANTABILITY OR FITNESS FOR A PARTICULAR PURPOSE. FLUKE SHALL NOT BE LIABLE FOR ANY SPECIAL, INDIRECT, INCIDENTAL, OR CONSEQUENTIAL DAMAGES OR LOSSES, INCLUDING LOSS OF DATA, ARISING FROM ANY CAUSE OR THEORY.

Since some countries or states do not allow limitation of the term of an implied warranty, or exclusion or limitation of incidental or consequential damages, the limitations and exclusions of this warranty may not apply to every buyer. If any provision of this Warranty is held invalid or unenforceable by a court or other decision-maker of competent jurisdiction, such holding will not affect the validity or enforceability of any other provision.

Fluke Corporation
P.O. Box 9090
Everett, WA 98206-9090
U.S.A.

Fluke Europe B.V.
P.O. Box 1186
5602 BD Eindhoven
The Netherlands

11/99

To register your product online, visit <http://register.fluke.com>.

Table of Contents

Title	Page
Introduction	1
How to Contact Fluke	2
Safety Information	3
Radio Frequency Data	5
Accessories	7
Before You Start	8
How to Charge the Battery	9
Two-Bay Battery Charger Base	9
On-Imager AC Power Socket	9
Optional 12 V Vehicle Charger	10
Power On and Off	10
Features and Controls	11
Focus	13
Primary and Secondary Triggers	14
How to Use the Control Buttons	15
How to Use the Menus	15
Image Capture	17
IR-PhotoNotes™	17
Voice Annotation	18
Listen to a Voice Annotation	18
Edit Data Files	19
Save Data Files	19
SD Memory Card	20
Temperature Measurement	21
SmartView® Software	22
Menus	22
Measurement Menu	22
Range	23
Emissivity Adjustment	26
Reflected Background Temperature Compensation	28
TiR-Mode	29
Transmission/Transmittance Adjustment	30

Spot Temperatures	31
User-Definable Spot Markers	32
Center Box	33
Image Menu	34
Palette	34
IR-Fusion®	36
Color Alarm (Temperature Alarm)	37
Set High-Temperature Color Alarm	38
Set Low-Temperature/Dew Point Color Alarm	39
Outside/Inside Alarm	39
Display Graphics Presentation	40
Camera Menu	41
Compass	41
Video	42
Video Recording	43
Video Playback	43
Laser Pointer	44
LED Light (Torch)	45
Backlight	45
Fluke Connect™ Wireless System	46
CNX™ Wireless System	47
Memory Menu	48
Review Data Files	48
Delete Data Files	49
Settings Menu	50
Units	50
File Format	50
Auto Off	52
Date	53
Time	54
Language	55
Imager Information	55
Maintenance	56
How to Clean the Case	56
Battery Care	57
General Specifications	58
Detailed Specifications	60

List of Tables

Table	Title	Page
1.	Symbols	6
2.	Accessories	7
3.	Packing Lists	8
4.	Features and Controls.....	11
5.	Overview of Controls	15
6.	Menu Overview	16
7.	Palettes	35
8.	Infrared and IR-Fusion Modes by Model	36

List of Figures

Figure	Title	Page
1.	Lens Cover Laser Warning.....	3
2.	IR-OptiFlex Focus	13
3.	SD Memory Card Insertion and Removal.....	20
4.	Level and Span Settings	25

Introduction

The Fluke Ti90, Ti95, Ti100, Ti105, Ti110, Ti125, TiR105, TiR110, and TiR125 Thermal Imagers (the Product or Imager) are handheld, infrared imaging cameras for use in many applications. These applications include equipment troubleshooting, preventive and predictive maintenance, and building diagnostics. The Ti90, Ti95, and Ti100 are general-purpose Imagers. The Ti105, Ti110, and Ti125 are for industrial-commercial maintenance applications. The TiR105, TiR110 and TiR125 are optimized for building inspection and diagnostics applications.

All Imagers display thermal images on a high-visibility LCD screen and can save images to an SD memory card. Saved images and data can be transferred to a PC via the SD memory card or by a direct USB connection to the PC.

Fluke SmartView[®] software supports all Imager models. This software is a high-performance, professional software suite that allows for analysis and reporting. SmartView is available for free download at www.fluke.com/smartviewdownload. Depending on the model, the Voice Annotation and IR-PhotoNotes[™] features are also available.

Infrared images display in different color palettes on each Imager. The temperature measurement range is:

- Ti90, Ti95, Ti100, Ti105, Ti110 -20 °C to +250 °C
- Ti125 -20 °C to +350 °C
- TiR105, TiR110, TiR125 -20 °C to +150 °C

A rugged, rechargeable lithium-ion smart battery provides power to the Imager. Direct AC power is accessible with the included AC power adapter.

The Fluke Ti110, Ti125, TiR110, and TiR125 use the IR-OptiFlex[™] focus system. IR-OptiFlex keeps the Imager in good focus at distances more than four feet. It also allows the flexibility of one-touch manual focus to fine tune the image in close-up situations. The Fluke Ti90, Ti95, Ti100, Ti105, and TiR105 use a focus-free system with a large depth of field that keeps the image in good focus at distances more than four feet.

How to Contact Fluke

To contact Fluke, call one of the following telephone numbers:

- USA: 1-800-760-4523
- Canada: 1-800-36-FLUKE (1-800-363-5853)
- Europe: +31 402-675-200
- Japan: +81-3-6714-3114
- Singapore: +65-6799-5566
- Anywhere in the world: +1-425-446-5500

Or, visit Fluke's website at www.fluke.com.

To register your Product, visit register.fluke.com.

To view, print, or download the latest manual supplement, visit us.fluke.com/usen/support/manuals.

To download SmartView[®] software visit www.fluke.com/smartviewdownload.

To download the Fluke Connect™ app, go to iTunes or Google app store and download Fluke Connect.

Safety Information

A **Warning** identifies hazardous conditions and actions that could cause bodily harm or death. A **Caution** identifies conditions and actions that could damage the Product or cause permanent loss of data.

Warning

To prevent eye damage and personal injury:

- Do not look into the laser. Do not point laser directly at persons or animals or indirectly off reflective surfaces.
- Do not look directly into the laser with optical tools (for example, binoculars, telescopes, microscopes). Optical tools can focus the laser and be dangerous to the eye.
- Use the Product only as specified or hazardous laser radiation exposure can occur.
- Do not open the Product. The laser beam is dangerous to eyes. Have the Product repaired only through an approved technical site.

Additional laser warning information is on the inside of the Product lens cover, see Figure 1.

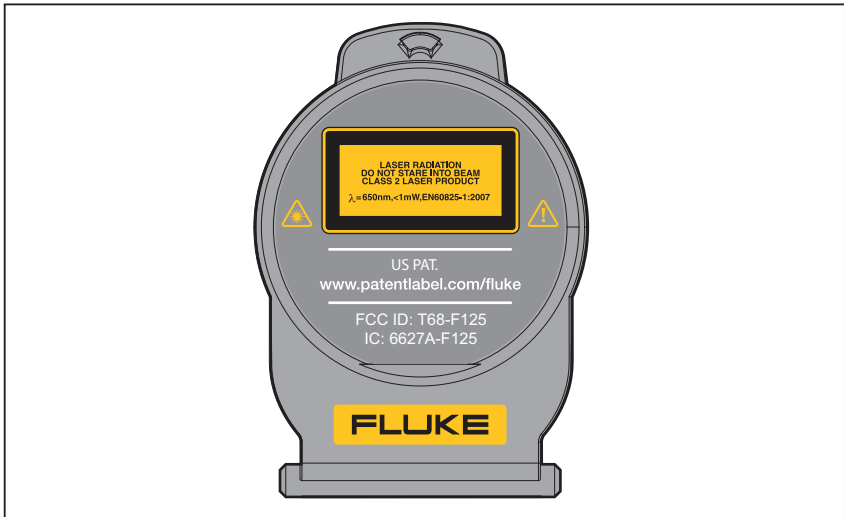

Figure 1. Lens Cover Laser Warning

gju05.eps

⚠ Warning

To prevent personal injury:

- Read all safety information before you use the Product.
- Carefully read all instructions.
- Use the Product only as specified, or the protection supplied by the Product can be compromised.
- Replace the batteries when the low battery indicator shows to prevent incorrect measurements.
- Do not use the Product around explosive gas.
- Do not use the Product if it operates incorrectly.
- Do not use the Product if it is damaged.
- Disable the Product if it is damaged.
- See emissivity information for actual temperatures. Reflective objects result in lower than actual temperature measurements. These objects pose a burn hazard.
- Do not disassemble the battery.
- Use only Fluke approved power adapters to charge the battery.
- Do not disassemble or crush battery cells and battery packs.
- Use only specified replacement parts.
- Have an approved technician repair the Product.

Radio Frequency Data

Note

- *Changes or modifications to the wireless 2.4 GHz radio not expressly approved by Fluke Corporation could void the user's authority to operate the Product.*
- *This section does not apply to the Ti90 and Ti95 models.*

This Product complies with Part 15 of the FCC Rules. Operation is subject to the two conditions that follow:

1. This Product cannot cause interference.
2. This Product must accept any interference, including interference that can cause undesired operation of the device.

Class B digital device: A digital device that is marketed for operation in a residential environment not withstanding use in commercial, business and industrial environments. Examples of such devices include, but are not limited to, personal computers, calculators, and equivalent electronic devices that are marketed for operation by the general public.



















The Product was tested and found to comply with the limits for a Class B digital device, pursuant to Part 15 of the FCC Rules. These limits are designed to provide reasonable protection against harmful interference in a residential installation. This equipment generates, uses, and can radiate radio frequency energy and, if not installed and used in accordance with the instructions, can cause harmful interference to radio communications. However, there is no guarantee that interference will not occur in a particular installation. If this equipment does cause harmful interference to radio or television reception, which can be determined by turning the equipment off and on, the user is encouraged to try to correct the interference by one or more of the measures that follow:

- Reorient or relocate the receiving antenna.
- Increase the separation between the equipment and receiver.
- Consult the dealer or an experienced radio/TV technician for help.

The term "IC:" before the radio certification number only signifies the device meets Industry's Canada technical specifications.

Table 1 is a list of symbols used on the Imager and in this manual.

Table 1. Symbols

Symbol	Description	Symbol	Description
	Battery status. Battery charging when animated.		Connected to ac power. Battery removed.
	Audio indicator		Audio recording associated with the displayed image.
	Pause recording indicator		IR-PhotoNotes™ indicator
	Video recording in process		Video file indicator
	On/Off Symbol.		Sleep mode.
	Important information. See manual.		Warning. Laser.
	Conforms to relevant Australian standards.		Conforms to relevant Canadian and US standards.
	Conforms to relevant South Korean EMC standards.		Japan Quality Association
	Conforms to requirements of European Union and European Free Trade Association.		
	This Product contains a lithium-ion battery. Do not mix with the solid waste stream. Spent batteries should be disposed of by a qualified recycler or hazardous materials handler per local regulations. Contact your authorized Fluke Service Center for recycling information.		
	This product complies with the WEEE Directive (2002/96/EC) marking requirements. The affixed label indicates that you must not discard this electrical/electronic product in domestic household waste. Product Category: With reference to the equipment types in the WEEE Directive Annex I, this product is classed as category 9 “Monitoring and Control Instrumentation” product. Do not dispose of this product as unsorted municipal waste. Go to Fluke's website for recycling information.		

Accessories

Table 2 is a list of the accessories available for the Imager.

Table 2. Accessories

Model	Description	PN
FLK-TI-SBP3	Smart Battery Pack	3440365
FLK-TI-SBC3	Charging Base/Power Supply with Adapters	3440352
TI-CAR CHARGER	12 V Vehicle Charger Adapter	3039779
FLK-TI-VISOR2	Sun Visor	3996500
FLK-TI-TRIPOD2	Tripod Mounting Accessory	3996517
BOOK-ITP	Introduction to Thermography Principles	3413459
FC-SD8GB	Fluke Connect™ Wireless SD Card (where available)	4463628

Before You Start

Carefully unpack the items in Table 3.

Table 3. Packing Lists

Item	Ti90	Ti95	Ti100 Ti105 TiR105	Ti110 TiR110	Ti125	TiR125
Thermal Imager	●	●	●	●	●	●
Two-Bay Battery Charge Base					●	●
Lithium-ion Smart Battery	1	1	1	1	2	2
Hard Carrying Case			●	●	●	●
USB Cable	●	●	●	●	●	●
Fluke Connect™ Wireless SD Card ^[1]	●	●	●	●	●	●
SD Memory Card ^[2]	●	●	●	●	●	●
Multi-format USB Memory Card Reader					●	●
Soft Transport Bag	●	●	●	●	●	●
Adjustable Hand Strap (Left-hand or Right-hand use)		●	●	●	●	●
Users Manuals ^[3]	To view, print, or download the manual, visit us.fluke.com/user/support/manuals .					
Quick Reference Card	●	●	●	●	●	●
Warranty Registration Card	●	●	●	●	●	●
[1] Fluke Connect™ is not available in all countries.						
[2] Fluke recommends the SD memory card that is supplied with the Imager. Fluke does not warrant the use or reliability of aftermarket SD memory cards of different brands or capacities.						
[3] To request a printed manual, email Fluke at TPubs@fluke.com . Specify the product name and language preference in the subject line.						

How to Charge the Battery

Before you use the Imager for the first time, charge the battery for a minimum of two and one-half hours. The battery status shows on the five-segment charge indicator.

Note

New batteries are not fully charged. Two to ten charge/discharge cycles are necessary before the battery charges to its maximum capacity.

To charge the battery, use one of the options that follow:

Two-Bay Battery Charger Base



1. Connect the ac power supply to the ac wall outlet and connect the dc output to the charger base.
2. Put one or two smart batteries into bays of charger base.
3. Charge batteries until charge indicators show “full.”
4. Remove smart batteries and disconnect the power supply when batteries are fully charged.

On-Imager AC Power Socket

1. Connect the ac power adapter into an ac wall outlet and connect the dc output to the Imager’s ac power socket.  flashes in the upper left-hand corner of the display while the battery charges with the ac power adapter.
2. Charge until the charge indicator on the display does not flash.
3. Disconnect ac power adapter when the smart battery is fully charged.

Note

Make sure that the Imager is near room temperature before you connect it to the charger. See the charging temperature specification. Do not charge in hot or cold areas. When you charge in extreme temperatures, battery capacity may be decreased.

 shows in the upper left-hand corner of the display when the Imager is connected to ac power and the battery is removed. When the Imager’s power is off and the ac power adapter is connected,  flashes in the center of the display to show that the battery charge is in process.

Keep the Imager attached to the charger until the battery condition icon shows a full charge. If you remove the Imager from the charger before a full charge shows, it may have a reduced run-time.

Note

When the battery is connected to ac power, or the unit is in video mode, the Sleep Mode/Auto Off feature is disabled automatically.

Optional 12 V Vehicle Charger

1. Connect the 12 V adapter into the 12 V accessory socket of the vehicle.
2. Connect the output to the ac power socket of the Imager.
3. Charge until the indicator shows *full* on the screen.
4. Disconnect the 12 V adapter and Imager when battery is fully charged.

⚠ Caution

To prevent damage to the Imager, remove it from the DC car charger before you start or jump start the vehicle.

Power On and Off

To turn the Imager on or off, push and hold the green Power **(I)** button above the LCD for two seconds, see Table 4. When the Auto Off feature is on, the Imager goes into Sleep Mode after five minutes of inactivity and shows **(II)** on the display. Press any key to restart the Imager. After 20 minutes of inactivity, the Imager turns off. For information about how to set this feature, see page 52.

Note

All thermal imagers need sufficient warm-up time for the most accurate temperature measurements and best image quality. This time can often vary by model and by environmental conditions. Although most imagers are fully warmed up in 3-5 minutes, it is always best to wait a minimum of 10 minutes if the most accurate temperature measurement is very important to your application. When you move an Imager between environments with large differences in ambient temperature, more adjustment time can be required.

Features and Controls

Features and controls for your Imager will vary by model. Use Table 4 as a reference for the features that are included with your model.

Table 4. Features and Controls

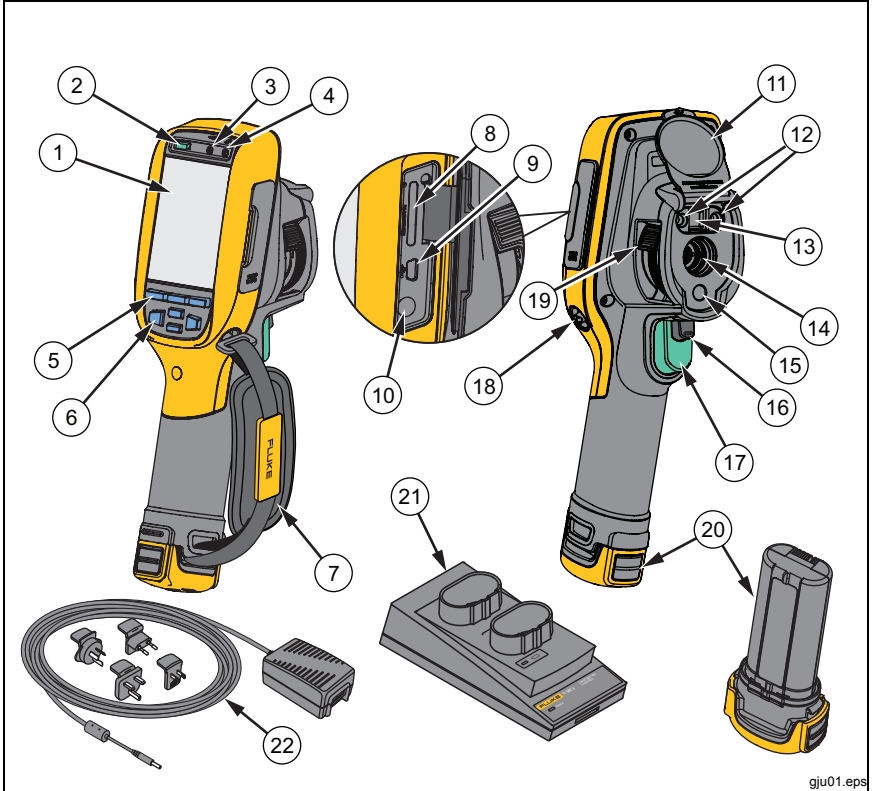

gju01.eps

Item	Description	Ti90	Ti95	Ti100	Ti105	Ti110	Ti125	TiR105	TiR110	TiR125
①	LCD Display	All Models								
②	⏻ Power On/Off	All Models								
③	Speaker			●	●	●	●	●	●	●
④	Microphone			●	●	●	●	●	●	●

Table 4. Features and Controls (cont.)

Item	Description	Ti90	Ti95	Ti100	Ti105	Ti110	Ti125	TiR105	TiR110	TiR125
⑤	Function Buttons (F1, F2, and F3)	All Models								
⑥	Arrow Buttons	All Models								
⑦	Hand Strap		●	●	●	●	●	●	●	●
⑧	SD Memory Card Slot	All Models								
⑨	USB Cable Connection	All Models								
⑩	AC Adapter/Charger Input Terminal	All Models								
⑪	Retractable Lens Cover	All Models								
⑫	LED Light (Torch)				●	●	●	●	●	●
⑬	Visual Camera and Lens	●	●		●	●	●	●	●	●
⑭	Infrared Camera Lens	All Models								
⑮	Laser Pointer			●	●	●	●	●	●	●
⑯	Secondary Trigger			●	●	●	●	●	●	●
⑰	Primary Trigger	All Models								
⑱	Hand Strap Anchor Post (Right and Left)	All Models								
⑲	IR-OptiFlex™ Focus Control					●	●		●	●
⑳	Lithium-ion Smart Battery	All Models								
㉑	2-Bay Battery Charging Base						●			●
㉒	AC Power Adapter with Universal Adapter	All Models								

Focus

Models Ti110, Ti125, TiR110, and TiR125 have IR-OptiFlex focus. The Ti90, Ti95, Ti100, Ti105, and TiR105 use a large depth of field focus-free system. Models with IR-OptiFlex focus can operate in a focus-free mode, but also have the flexibility for close focus situations (<122 cm/48 inches) with a one-touch, fine-tune focus capability. See Figure 2.

The focus-free system can focus at a minimum distance of 122 cm (48 in) and beyond with no adjustment.

Correct focus is important in all imaging applications. Correct focus makes sure that the infrared energy is correctly directed onto the pixels of the detector. Without the correct focus, the thermal image can be blurry and the radiometric data will be inaccurate. Out-of-focus infrared images are frequently unusable or of little value.

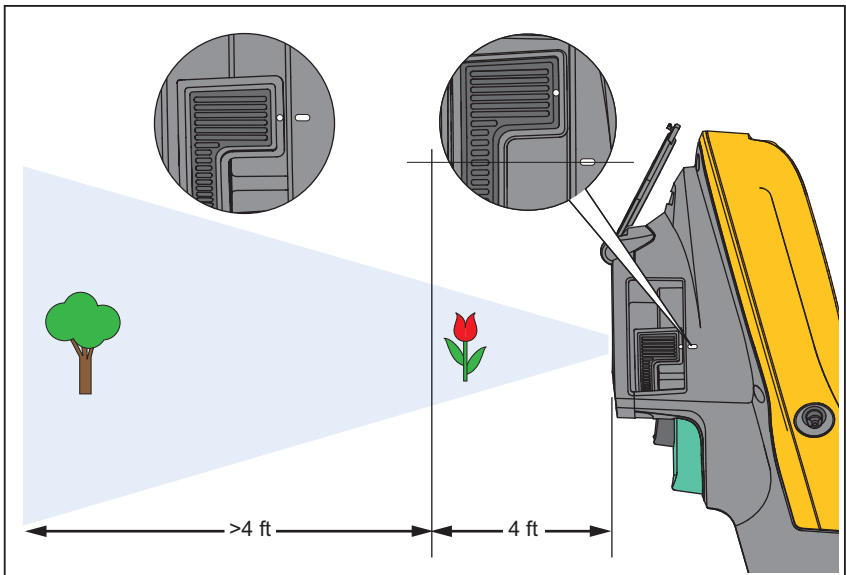

gju04.eps

Figure 2. IR-OptiFlex Focus

To operate the IR-OptiFlex focus in the focus-free mode, align the white dot on the focus control with the white dot on the body of the Imager. You will also feel a detent at this position. See Figure 2. In this mode, in addition to correctly focused infrared images, the IR-Fusion must always be in proper alignment.

To operate with IR-OptiFlex focus in manual mode or to fine tune the focus, turn the one-touch focus control in a clockwise or counterclockwise direction. As you turn the focus control, you will see a live thermal image on the display as it changes. When your target comes into focus, it shows a sharper image. When the target moves out of focus, the image becomes blurry.

Primary and Secondary Triggers

The two-part trigger is located in the standard trigger position for a pistol-grip device. The larger, green trigger is the primary trigger. The smaller, black trigger is the secondary trigger.

In normal operation (video is off), the function of the primary trigger is to capture a thermal image for possible storage to memory by the user. When video is on, the primary trigger is the start/stop for video recording.

The secondary trigger operates the laser and LED light. For information about how to enable the laser and torch, see pages 44 and 45.

Note

The secondary trigger does not apply to the Ti90 and Ti95 models.

How to Use the Control Buttons

Three function buttons (**F1**, **F2**, **F3**) and four arrow buttons (**←**, **→**, **▲**, and **▼**) are the primary controls. These buttons move the cursor through the menu structure to set the features.

Table 5 is an overview of the buttons and their actions. In live Manual Mode, the arrow buttons are always active to adjust Level and Span.

Table 5. Overview of Controls

Button	Button Label / Action
F3 , Trigger	Cancel
F1 , Trigger	Done (exit from Menu structure)
F1 , →	Select or OK
F2 , ←	Back
▲ , ▼	Move cursor to highlight an option
→ , ←	Fast forward/rewind (video mode only)

How to Use the Menus

The menus, coupled with the three function buttons (**F1**, **F2**, **F3**) and arrow buttons, are the access for thermal image display, camera features, memory review, and settings for date, time, language, units, file format, and Imager information.

To open the primary menu, push **F2** or **→**. The primary menu shows five secondary menus for Measurement, Image, Camera, Memory, and Settings. The text above each function button (**F1**, **F2**, **F3**) applies to that button throughout all menu screens.

Push **F2** to open the primary menu and push **▲**/**▼** to cycle through the secondary menu. Each secondary menu lists an options menu. Push **▲**/**▼** to cycle through the options.

The primary, secondary, and option menus close 10 seconds after the last push of a function button. The option selection menu stays open until you make the selection, go up a menu level, or cancel the action. Table 6 is list of features by model that you access through the menus.

Table 6. Menu Overview

Menu Features and Adjustments	Ti90	Ti95	Ti100	Ti105	Ti110	Ti125	TiR105	TiR110	TiR125
IR-PhotoNotes™					●	●		●	●
Voice Annotation					●	●		●	●
Level and Span	All Models								
Emissivity Selection	All Models								
Reflected Background Temperature Compensation	All Models								
Transmission Correction					●	●		●	●
Spot Temperatures (hot and cold spot markers)		●				●			●
User-definable Spot Markers					●	●		●	●
Expand/Contract Center Box (MIN/MAX/AVG)				●	●	●	●	●	●
Fixed-Size Center Box (MIN/MAX/AVG)		●							
Color Palettes	All Models								
IR-Fusion®	●	●		●	●	●	●	●	●
Color Alarms (Temperature Alarms)									
High Temperature				●	●	●	●	●	●
Low Temperature (Dewpoint)					●	●		●	●
Isotherm						●			●
User-selectable Display Graphics	All Models								
Cardinal Compass					●	●		●	●
Laser Pointer (on/off)			●	●	●	●	●	●	●
LED Light (Torch)				●	●	●	●	●	●
Fluke Connect™ Wireless System	All Models								
CNX™ Wireless System			●	●	●	●	●	●	●
User-selectable Temperature Scale (°C/°F)	All Models								
User-selectable File Format									
.IS2, .JPG, .BMP	●	●	●	●	●	●	●	●	●
.IS3						●			●
.AVI					●	●		●	●
User-selectable Sleep/Auto Off	All Models								
Time and Date Settings	All Models								
Language Selection	All Models								
Center Point Temperature	All Models								

Image Capture

Point the imager at the object or area of interest. Make sure that the object is in focus. Pull and release the primary trigger. This will capture and freeze the image. To cancel the captured image, pull the primary trigger again or **F3** to return to the Live view.

Depending on the selected file format settings, the Imager shows the captured image and a menu bar. The menu bar lets you save the image, edit some image settings, and add voice annotation or IR-PhotoNotes. To change the file format, see *File Format* on page 50.

IR-PhotoNotes™

IR-PhotoNotes™ are photograph annotations that allow the user to capture and add multiple visible images of various objects, text, or other information that is related to the analysis and reporting of an infrared image. Examples of an annotation include motor name plates, printed information or warning signs, larger views of the environment or room, and related equipment. Up to three images can be captured with the visible image that is stored with the infrared image as part of IR-Fusion technology. These visible images are only available in the .is2 file format and are stored in the file so you do not need to collate multiple files at a later time.

To add IR-PhotoNotes:

1. With an image in the buffer, push **F2** to open the **EDIT IMAGE** menu.
2. Push **▲**/**▼** to highlight **IR-PhotoNotes**.
3. Push **▶** to enter the Picture mode.
4. Focus Imager on the object and pull the primary trigger.
5. Push **F2** to continue.
6. Push **F1** save the picture with the image.

Voice Annotation

The maximum recording time is 60 seconds for each image reviewable playback (varies by model).

To add a voice (audio) record:

1. With an image in the buffer, push **F2** to open the **EDIT IMAGE** menu.
2. Push **▲**/**▼** to highlight **Add Audio**.
3. Push **F1** to record up to 60 seconds of audio. The display updates to show the recorded time.
4. Push **F1** to pause the recorder.
5. Push **F2** when done.
6. Push **F1** to review the audio file or **F2** to save the audio with the image.

Listen to a Voice Annotation

The voice (audio) record replays through the speaker.

To playback an .is2 file on the SD memory card:

1. Do the steps in the *Review Data Files* section on page 48 to see the image on the display.
2. Push **F1**.
3. Push **F1** or **▶▶** to set **Audio**.
4. Push **F1** to listen to the audio.
5. Push **F1** again to pause the audio.

Edit Data Files

Before saving a file, you can edit or modify the image.

To edit:

1. With an image in the buffer, push **F2** to open the **EDIT IMAGE** menu.
2. Push **▲**/**▼** to highlight **Edit Image**.
3. Push **▶▶** to open the **EDIT IMAGE** menu.
4. Push **▲**/**▼** to highlight an option.
5. Push **F1** to save the changes with the file.

Save Data Files

To save an image as a data file:

1. Focus on the object of interest or inspection area.
2. Pull the trigger to capture the image. The image is now in the buffer and you can save or edit.
3. Push **F1** to save the image as a file and go back to the live view.

SD Memory Card

To eject an SD memory card, push in on the exposed edge of the card and then release. The card should pop partially out after you release it. Carefully pull the card out of the slot.

To use the SD memory card, make sure that the write-protect lock is open. See Figure 3. Carefully push the card into the slot with the card label facing away from the LCD. Push the card in until it catches.

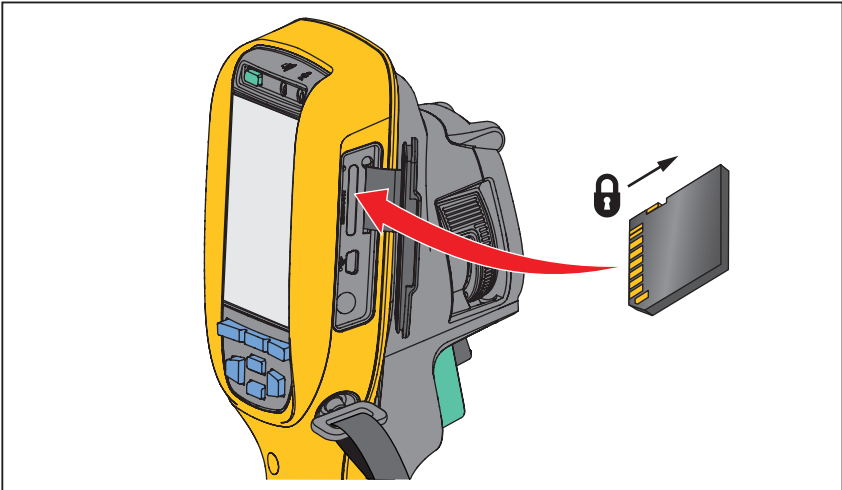

Figure 3. SD Memory Card Insertion and Removal

gju03.eps

For information about how to save data, see page 19. For information about how to view or erase a stored image, see page 48.

Temperature Measurement

All objects radiate infrared energy. The quantity of energy radiated is based on the actual surface temperature and the surface emissivity of the object. The Imager senses the infrared energy from the surface of the object and uses this data to calculate an estimated temperature value. Many common objects and materials such as painted metal, wood, water, skin, and cloth are very good at radiating energy and it is easy to get relatively accurate measurements. For surfaces that are good at radiating energy (high emissivity), the emissivity factor is $\geq 90\%$ (or 0.90). This approach does not work on shiny surfaces or unpainted metals as they have an emissivity of < 0.60 . These materials are not good at radiating energy and are classified as low emissivity. To more accurately measure materials with a low emissivity, an emissivity correction is necessary. Adjustment to the emissivity setting will usually allow the Imager to calculate a more accurate estimate of the actual temperature.

Warning

To prevent personal injury, see emissivity information for actual temperatures. Reflective objects result in lower than actual temperature measurements. These objects pose a burn hazard.

Note

Surfaces with an emissivity < 0.60 make reliable and consistent determination of actual temperatures problematic. The lower the emissivity, the more potential error is associated with the Imager's temperature measurement calculations, even when emissivity and reflected background adjustments are attempted and performed properly.

More information is available on emissivity at <http://www.fluke.com/emissivity> and <http://www.fluke.com/emissivityexplanation>. We recommend the study of this topic to get the most accurate temperature measurements.

SmartView[®] Software

SmartView[®] software is available for free download for all Fluke infrared cameras and is supplied with the Ti100, Ti105, Ti110, Ti125, TiR105, TiR110, and TiR125. This software is intended for Fluke Imagers and contains features to analyze images, organize data and information, and make professional reports. SmartView[®] allows audio annotations and IR-PhotoNotes to be reviewed on a PC. SmartView[®] is used to export IR and visible images as .jpeg, .jpg, .jpe, .jfif, .bmp, .gif, .dib, .png, .tif, or .tiff formatted files.

Menus

The menus, together with the three function buttons (**F1** , **F2** , **F3**) and arrow buttons, are access for thermal image display, camera features, memory setup, and settings for date, time, language, units, file format, and Imager information.

Measurement Menu

The Measurement Menu has settings for the calculation and display of radiometric temperature measurement data related to the thermal images. These settings include the Range (Auto and Manual Level and Span adjustment), Emissivity, Background, Transmission, Spot Temperatures, Markers, and Center Box.

Range

Range (level and span) is set to automatically adjust or is set for manual adjustment. To choose between automatic or manual level and span, do the following:

1. Push **F2**.
2. Push **▲**/**▼** to highlight **Measurement**.
3. Push **F1** or **▶▶** to view the menu.
4. Push **▲**/**▼** to highlight **Range**.
5. Push **F1** or **▶▶** to view the menu.
6. Push **▲**/**▼** to toggle between the Auto and Manual ranging.
7. Push **F1** to set.
8. Push:
 - **F1** to set the change and go back to the live view.
 - **F2** or **◀◀** to set the change and go back to the previous menu.
 - **F3** to cancel the change and go back to the live view.

Fast Auto/Manual Range Toggle

When NOT in a menu mode, push  for ½ second to toggle between Auto Range and Manual Range.

Fast Auto Rescale

When in Manual Range and NOT in a menu mode, push  for ½ second to automatically rescale the level and span range for objects in the thermal field of view. This feature operates the Imager in a semi-automatic mode if manual fine re-adjustment of level and span with the arrow buttons is not necessary. Rescaling can be done as often, or as little, as needed.



Note

The Imager always powers up in the same Range mode, Auto or Manual, as when it was powered down.

Level for Manual Operation Mode

When put into manual ranging, the level setting moves the thermal span up or down within the total temperature range. See Figure 4. In the live manual mode, the arrow buttons are always available to adjust the level and span.

To set the level:

1. Push  to move the range to a higher temperature level.
2. Push  to move the range to a lower temperature level.

While you adjust the manual level, the scale along the right side of the display shows the thermal span as it moves to different levels within the total range.

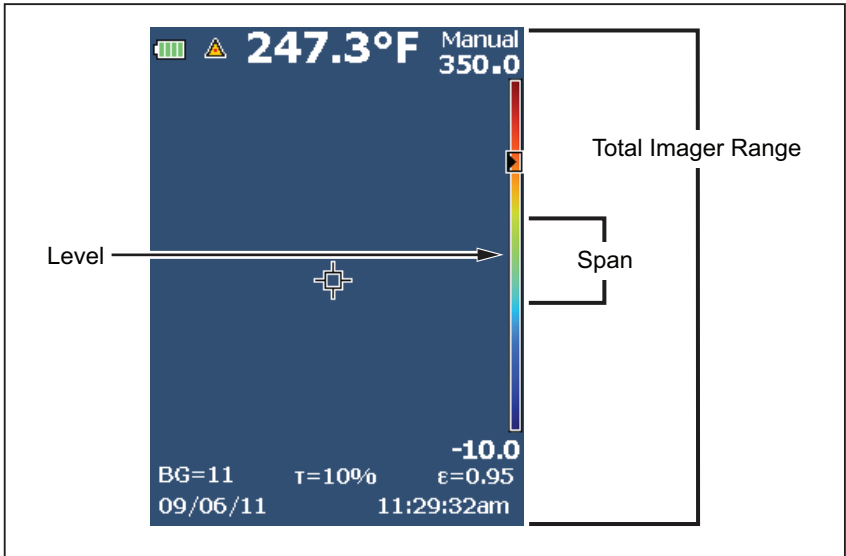



gju02.eps

Figure 4. Level and Span Settings

Temperature Span for Manual Operation Mode

When in manual mode, the span setting contracts or expands in a selected palette in a temperature range within the total range. See Figure 4. In the live manual mode, the arrow buttons are always available to adjust the level and span.

To adjust the temperature span:

1. Push  to increase or widen the temperature span.
2. Push  to decrease or narrow the temperature span.

While you adjust the manual span, the scale along the right side of the display shows the thermal span increasing or decreasing in size.

Emissivity Adjustment

The correct emissivity values are important for you to make the most accurate temperature measurements. Emissivity of a surface can have a large effect on the apparent temperatures that the Imager observes. Understanding the emissivity of the surface being inspected can, but may not always, allow you to obtain more accurate temperature measurements.

If you set a value that is <0.60 ,  shows on the Imager display with this caution:

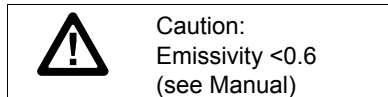

Note

Surfaces with an emissivity of <0.60 make reliable and consistent determination of actual temperatures problematic. The lower the emissivity, the more potential error is associated with the Imager's temperature measurement calculations. This is also true even when adjustments to the emissivity and reflected background adjustments are performed properly.







Emissivity is set directly as a value or from a list of emissivity values for some common materials.







Note

*If the Display is set to **Display All**, you see the information about current emissivity as $\epsilon = x.xx$.*

Adjust by Number













To set the emissivity value:

1. Push .
2. Push / to highlight **Measurement**.
3. Push  or  to view the menu.
4. Push / to highlight **Emissivity**.

5. Push **F1** or  to view the menu.
6. Push / to highlight **Adjust Number**.
7. Push **F1** or  to view the menu.
8. Push / to change the value.
9. Push:
 - **F1** to set the change and go back to the live view.
 - **F2** or  to set the change and go back to the previous menu.
 - **F3** to cancel the change and go back to the live view.

Select by Table









To select from a list of common materials:

1. Push **F2**.
2. Push / to highlight **Measurement**.
3. Push **F1** or  to view the menu.
4. Push / to highlight **Emissivity**.
5. Push **F1** or  to view the menu.
6. Push / to highlight **Select Table**.
7. Push **F1** or  to view the emissivity table.
8. Push / to change the value.
9. Push:
 - **F1** to set the change and go back to the live view.
 - **F2** or  to set the change and go back to the previous menu.
 - **F3** to cancel the change and go back to the live view.

Reflected Background Temperature Compensation

Compensation for reflected background temperature is set in the Background tab. Very hot objects or very cold objects can affect the apparent temperature and measurement accuracy of the target or object of interest, especially when surface emissivity is low. Adjustment of the reflected background temperature can make the temperature measurement better in many situations. For more information, see *Emissivity Adjustment*.

To adjust the background temperature:

1. Push **F2**.
2. Push / to highlight **Measurement**.
3. Push **F1** or  to view the menu.
4. Push / to highlight **Background**.
5. Push **F1** or  to view the menu.
6. Push / to change the value.
7. Push:
 - **F1** to set the change and go back to the live view.
 - **F2** or  to set the change and go back to the previous menu.
 - **F3** to cancel the change and go back to the live view.

Note

If the Display is set to **Display All**, you see the information about current reflected background temperature as **BG = xx.x**.

TiR-Mode

TiR-Mode (thermal sensitivity) expresses the ability of an infrared camera to display a very good image even if the thermal contrast in a scene is low. A camera with good sensitivity can distinguish objects in a scene that have very little temperature difference between them.

Sensitivity is most often measured by a parameter called Noise Equivalent Temperature Difference or NETD. NETD is defined as the amount of infrared radiation required to produce an output signal equal to the system's noise. The noise rating of the system should be as low as possible.

To adjust the TiR-Mode:

1. Push **F2**.
2. Push **▲**/**▼** to highlight **Image**.
3. Push **F1** or **▶▶** to view the menu.
4. Push **▲**/**▼** to highlight **TiR-Mode**.
5. Push **F1** or **▶▶** to view the menu.
6. Push **▲**/**▼** to change the value.
7. Push:
 - **F1** to set the change and go back to the live view.
 - **F2** or **◀◀** to set the change and go back to the previous menu.
 - **F3** to cancel the change and go back to the live view.

When TiR-Mode is turned on, images are enhanced with the improvement to the image clarity of live scan targets. This mode is used for building envelope applications such as roofing, restoration, and remediation. Response times in this mode increase (slower refresh rate) and the maximum temperature range is lower.

Note

When you scan with the TiR-Mode on, the Imager displays a slight blurring effect. For best image results, hold the camera steady. Image enhancement cannot be applied to images after they are taken.

Transmission/Transmittance Adjustment

When you do infrared inspections through infrared-transparent windows (IR windows), not all of the infrared energy emitted from the objects of interest is transmitted through the optical material in the window. If the transmission percentage of the window is known, you can adjust this percentage in the Imager or in the SmartView[®] software. Adjustment of the transmission correction can make the accuracy of the temperature measurement better in many situations.

To adjust the transmission percentage:

1. Push **F2**.
2. Push **▲**/**▼** to highlight **Measurement**.
3. Push **F1** or **▶** to view the menu.
4. Push **▲**/**▼** to highlight **Transmission**.
5. Push **F1** or **▶** to view the menu.
6. Push **▲**/**▼** to adjust the percentage.
7. Push:
 - **F1** to set the change and go back to the live view.
 - **F2** or **◀** to set the change and go back to the previous menu.
 - **F3** to cancel the change and go back to the live view.

Note

If Display Information is set to **Display All**, you see the information about current transmission correction as $\tau = xx$.

Spot Temperatures

The Spot Temperatures are floating HI and LO temperature indicators that move on the display as the temperature measurements of the image fluctuate.

To turn on/off the hot and cold spot indicators:

1. Push **F2**.
2. Push **▲**/**▼** to highlight **Measurement**.
3. Push **F1** or **▶▶** to view the menu.
4. Push **▲**/**▼** to highlight **Spot Temp**.
5. Push **F1** or **▶▶** to view the menu.
6. Push **▲**/**▼** to toggle this function **ON** or **OFF**.
7. Push:
 - **F1** to set the change and go back to the live view.
 - **F2** or **◀◀** to set the change and go back to the previous menu.
 - **F3** to cancel the change and go back to the live view.









Note

If the Display is set to **Display All**, you see the information about current transmission correction as $\tau = \text{xxx}\%$.





User-Definable Spot Markers

Up to three adjustable, fixed-temperature spot markers are available on the display. You can use these markers to highlight a region before you save the image. The marker selection is set as All Off, One Marker, Two Markers, or Three Markers.

To set a Marker:

1. Push **F2**.
2. Push / to highlight **Measurement**.
3. Push **F1** or  to view the menu.
4. Push / to highlight **Markers**.
5. Push **F1** or  to view the menu.
6. Push the / to highlight the function between **All Off**, **One Marker**, **Two Markers**, and **Three Markers**.
7. Push **F1** or  to set the marker option and go to the "Move Marker" display. You will see the Move Marker icon and the labels on the function buttons change to **Done**, **Next**, and **Cancel**.

To change the Marker position on the display:

1. Push     to move the Marker location on the image.
2. Push **F2** to highlight the next marker. Do Step 1 again.
3. Do Step 2 for a third marker.
4. Push **F1** when done.









Center Box

The Center Box feature is an adjustable temperature measurement zone (box) that you can center on the infrared image. On some models, this zone (box) expands and contracts to different levels in the infrared image. The zone lets the user see an approximate maximum (MAX), average (AVG), and minimum (MIN) temperature measurement in that area.

Note

When the Center Box feature is on, the Hot and Cold Spot Temperature markers do not function. The user-definable spot markers only function within the selected Center Box area. The level and span of the Imager is also adjusted to the thermal scene within the Center Box.

To enable or disable the Center Box feature:

1. Push **F2**.
2. Push / to highlight **Measurement**.
3. Push **F1** or  to view the menu.
4. Push / to highlight **Center Box**.
5. Push **F1** or  to view the menu.
6. Push / to toggle the function **ON** or **OFF**.

To set the size of the **Center Box** when enabled:







1. Push / to highlight **Set Size**.
2. Push **F1** or  to view the display.
3. Push  to increase the size of the **Center Box**.
4. Push  to reduce the size of the **Center Box**.
5. When satisfied with the size of the **Center Box**, push:
 - **F2** or  to set the change and go back to the previous menu.
 - **F3** to cancel the change and go back to the live view.

Image Menu

The Image menu has controls for different features used in the presentation of the infrared image on the Imager's LCD and some saved image and video files.

Note

Data saved as .is2 or .is3 formats can easily be modified within SmartView software. Still images saved in .bmp or .jpg format, as well as video saved in .avi format will retain image settings at the time of capture and save.

Palette









The Palette menu lets you change the false-color presentation of the infrared images on display or captured. A variety of palettes are available, depending on the model. Some palettes are more suitable for specific applications and can be set as required. Two palette presentation modes are available. The Standard Palettes offer an equal, linear presentation of colors that allow for best presentation of detail. The Ultra Contrast Palettes offer a weighted presentation of colors. These palettes work best in situations with high thermal contrast for extra color contrast between the high temperatures and low temperatures. Table 7 lists the palettes that are available for each model.

Table 7. Palettes

	Ti90	Ti95	Ti100	Ti105	Ti110	Ti125	TiR105	TiR110	TiR125
Standard Palettes									
Grayscale	•	•	•	•	•	•	•	•	•
Grayscale Inverted				•	•	•	•	•	•
Blue-Red	•	•	•	•	•	•	•	•	•
High Contrast		•		•	•	•	•	•	•
Hot Metal		•		•	•	•	•	•	•
Ironbow	•	•	•	•	•	•	•	•	•
Amber		•	•	•	•	•	•	•	•
Amber Inverted				•	•	•	•	•	•
Ultra Contrast™ Palettes									
Grayscale					•	•		•	•
Grayscale Inverted						•			•
Blue-Red					•	•		•	•
High Contrast						•			•
Hot Metal						•			•
Ironbow					•	•		•	•
Amber						•			•
Amber Inverted						•			•

To set a palette:

1. Push **F2**.
2. Push **▲**/**▼** to highlight **Measurement**.
3. Push **F1** or **▶▶** to view the menu.
4. Push **▲**/**▼** to highlight **Image**.

5. Push **F1** or  to view the menu.
6. Push / to highlight **Palette**.
7. Push **F1** or  to view the menu.
8. Push / to highlight **Standard** or **Ultra Contrast**.
9. Push / to select a palette.
10. Push:
 - **F1** to set the change and go back to the live view.
 - **F2** or  to set the change and go back to the previous menu.
 - **F3** to cancel the change and go back to the live view.

IR-Fusion[®]

IR-Fusion[®] makes it easier to understand infrared images through the use of an aligned visible image and infrared image. The Imager automatically captures a visible image with every infrared image to show you exactly what you see and then allows you to more effectively show it to others.

IR-Fusion has different modes that vary by model, see Table 8. Full Visible mode is also available. (The Fluke Ti100 does not have IR-Fusion and can only display a full infrared image.)

Table 8. Infrared and IR-Fusion Modes by Model

	Ti90	Ti95	Ti100	Ti105	Ti110	Ti125	TiR105	TiR110	TiR125
Full AutoBlend™ (min IR mode)					•	•		•	•
Full AutoBlend™ (mid IR mode)				•	•	•	•	•	•
Max IR (Full Thermal)	•	•	•	•	•	•	•	•	•
Full Visible	•	•		•	•	•	•	•	•
Picture-in-Picture AutoBlend™ (min)					•	•		•	•
Picture-in-Picture AutoBlend™ (mid)				•	•	•	•	•	•
Picture-in-Picture AutoBlend™ (max)		•		•	•	•	•	•	•
<i>Note: Ti105 and TiR105 models have aligned IR-Fusion from 1.2 m to 4.6 m (4 ft to 15 ft).</i>									

To set the IR-Fusion mode:

1. Push **F2** .
2. Push **▲**/**▼** to highlight **Measurement**.
3. Push **F1** or **▶▶** to view the menu.
4. Push **▲**/**▼** to highlight **Image**.
5. Push **F1** or **▶▶** to view the menu.
6. Push **▲**/**▼** to highlight **IR-Fusion**.
7. Push **F1** or **▶▶** to view the menu.
8. Push **▲**/**▼** to highlight an option.
9. Push:
 - **F1** to set the change and go back to the live view.
 - **F2** or **◀◀** to set the change and go back to the previous menu.
 - **F3** to cancel the change and go back to the live view.







Color Alarm (Temperature Alarm)

Certain models have various apparent temperature color alarms. The high-temperature color alarm shows a full visible image and only shows infrared information on objects or areas that are above the set apparent temperature alarm level. The low-temperature/dew point color alarm shows a full visible image and only shows infrared information on objects or areas that are below the set apparent temperature/dew point color alarm level. The user must manually find and set these parameters. Certain models also display color isotherms, or infrared information, inside or outside of a set of both high and low limits.

Note







The Imager does not sense ambient or surface dew point level automatically. To use the low-temperature color alarm function as a dew point color alarm, manual determination and input of surface dew point temperature will yield the best results. Depending on the situation, the colors presented will, or will not, actually show areas with possible dew point condensation.

To view the Color Alarm menu:

1. Push **F2**.
2. Push / to highlight **Image**.
3. Push **F1** or  to view the menu.
4. Push / to highlight **Color Alarm**.
5. Push **F1** or  to view the menu.









Set High-Temperature Color Alarm

To set a high-temperature color alarm:

1. From the **Color Alarm** menu, push / to highlight the option: **Set High Alarm**.
2. Push  to open the Color Alarm menu.
3. Push / to adjust the temperature setting.
4. Push:
 - **F1** to set the change and go back to the live view.
 - **F2** or  to set change and go back to the previous menu.
 - **F3** to cancel the change and go back to the live view

Set Low-Temperature/Dew Point Color Alarm







To set a low-temperature/dew point color alarm:

1. From the **Color Alarm** menu, push / to highlight **Set Low Alarm**.
2. Push  to open the Color Alarm menu.
3. Push / to adjust the temperature setting.
4. Push:
 -  to set the change and go back to the live view.
 -  or  to set the change and go back to the previous menu.
 -  to cancel the change and go back to the live view.

Outside/Inside Alarm

If you set values for the high-temperature color alarm and a low-temperature color alarm, the Imager will have the options for inside or outside isotherm color alarms.













To set an outside/inside isotherm color alarm:

1. From the **Color Alarm** menu, push / to highlight **Outside or Inside**.
2. Push:
 -  to set the change and go back to the live view.
 -  or  to set the change and go back to the previous menu.
 -  to cancel the change and go back to the live view.

Display Graphics Presentation

The options for how you view the on-screen graphics are in the Display menu. These options are Display All, Details and Scale, Scale Only, and Image Only.

To set the display:

1. Push **F2**.
2. Push / to highlight **Measurement**.
3. Push **F1** or  to view the menu.
4. Push / to highlight **Image**.
5. Push **F1** or  to view the menu.
6. Push / to highlight **Display**.
7. Push **F1** or  to view the menu.
8. Push / to highlight an option.
9. Push:
 - **F1** to set the change and go back to the live view.
 - **F2** or  to set the change and go back to the previous menu.
 - **F3** to cancel the change and go back to the live view.

Camera Menu

The Camera menu has controls and options for secondary camera features such as Compass, Video, Laser Pointer, Torch, and Backlight level.

Compass

The Imager includes an eight-point cardinal compass on the display. The compass has on and off functions. This compass lets you accurately record the direction the camera is pointing for analysis and reports.

To set the compass:

1. Push **F2**.
2. Push **▲**/**▼** to highlight **Camera**.
3. Push **F1** or **▶▶** to view the menu.
4. Push **▲**/**▼** to highlight **Compass**.
5. Push **F1** or **▶▶** to view the menu.
6. Push **▲**/**▼** to highlight **ON** or **OFF**.
7. Push **F1** to set the option.
8. Push:
 - **F1** to go back to the live view.
 - **F2** or **◀◀** to go back to the previous menu.
 - **F3** to cancel the change and go back to the live view.

Note

▲ shows on the display when the compass cannot make a reading.

Video









The Ti110, Ti125, TiR110, TiR125 have .avi (with mpeg encoding) video capture for a maximum of five minutes. The controls include stop, rewind, fast forward, and pause/play functions.

Ti125 and TiR125 have radiometric video. With radiometric (.is3) video, the thermal scene and complexity of the recorded data affects the amount of time (2.5 minutes to 5 minutes) available for video recording. The controls include stop, rewind, fast forward, and pause/play functions.

Streaming video output (Ti125, TiR125 only) is available with the USB connection to a PC with SmartView software.





The Video selection toggles between Video Off, Video/Audio, and Video Only. The video capture format is set in the Settings menu. For more information, see page 50.

To set:

1. Push **F2**.
2. Push / to highlight **Camera**.
3. Push **F1** or  to view the menu.
4. Push / to highlight **Video**.
5. Push **F1** or  to view the menu.
6. Push / to highlight an option.
7. Push **F1** to set the option.
8. Push:
 - **F1** to set the change and go back to the live view.
 - **F2** or  to set the change and go back to the previous menu.
 - **F3** to cancel the change and go back to the live view.

















Video Recording

To record:

1. Pull the primary trigger to start recording. The  icon shows in the upper left corner or the display and the recording time graphic at the bottom of the display shows the remaining time.
2. Pull the primary trigger to pause recording. The  icon shows in the upper left corner or the display.
3. Push  to end the recording session.
4. Push  to save the video file. The Imager displays the **VIDEO** menu as a prompt to disable the feature or continue in the same mode.

Video Playback

To playback:

1. Push .
2. Push / to highlight **Memory**.
3. Push  to view the thumbnails of saved files.
4. Push     to highlight a file for playback. All .avi files show the  icon in the upper right corner of the thumbnail.
5. Push  to set a file for playback.
6. Push  to start the playback. The  icon shows in the upper left corner of the display if an audio file is attached to the video file.
7. During playback, push  or  for fast forward and rewind. Push  to continue normal playback.
8. Push  to exit the playback mode.

Laser Pointer

The laser pointer is a sighting aid and is offset from the infrared camera. As a result, it may not always represent the exact center of the infrared or visible image.

















The laser dot does not appear on an infrared-only image, but does on visible-only or AutoBlend images. The laser dot cannot be seen in the visible channel of the IR-Fusion image if obscured by the center point marker graphic.

The laser pointer selections are Trigger Laser, Trigger Torch, and Laser/Torch. When set, pull the secondary trigger to turn on, release the secondary trigger to turn off.

Warning

To prevent eye damage and personal injury, do not look into the laser. Do not point laser directly at persons or animals or indirectly off reflective surfaces.

To set:

1. Push **F2** .
2. Push / to highlight **Camera**.
3. Push **F1**  or  to view the menu.
4. Push / to highlight **Laser/Torch**.
5. Push **F1**  or  to view the menu.
6. Push / to highlight an option.
7. Push **F1**  to set the option.
8. Push:
 - **F1**  to set the change and go back to the live view.
 - **F2**  or  to set the change and go back to the previous menu.
 - **F3**  to cancel the change and go back to the live view.

The laser warning symbol () shows in the Header zone of the display when the laser is turned on and you pull the secondary trigger.

LED Light (Torch)

The LED light illuminates darker work areas. When set, pull the secondary trigger to operate.

Note

When the LED light is on and an image is captured, the LED light momentarily shines brighter and functions as a visible camera flash.

To set:

1. Push **F2**.
2. Push **▲**/**▼** to highlight **Camera**.
3. Push **F1** or **▶▶** to view the menu.
4. Push **▲**/**▼** to highlight **Laser/Torch**.
5. Push **F1** or **▶▶** to view the menu.
6. Push **▲**/**▼** to highlight an option.
7. Push **F1** to set the option.
8. Push:
 - **F1** to set the change and go back to the live view.
 - **F2** or **◀◀** to set the change and go back to the previous menu.
 - **F3** to cancel the change and go back to the live view.

Backlight

The backlight level control is set to low, medium, and high. To set the backlight:

1. Push **F2**.
2. Push **▲**/**▼** to highlight **Camera**.
3. Push **F1** or **▶▶** to view the menu.
4. Push **▲**/**▼** to highlight **Backlight**.
5. Push **F1** or **▶▶** to view the menu.
6. Push **▲**/**▼** to highlight an option.
7. Push:
 - **F1** to set the change and go back to the live view.
 - **F2** or **◀◀** to set the change and go back to the previous menu.
 - **F3** to cancel the change and go back to the live view.

Fluke Connect™ Wireless System

The Imager supports the Fluke Connect™ Wireless System (may not be available in all regions). Fluke Connect™ is a system that wirelessly connects your Fluke test tools with an app on your smartphone. It enables you to see images from your infrared camera on your smartphone screen, save images to the asset's EquipmentLog™ history in the Fluke Cloud™, and share images with your team.

The Fluke Connect app works with the iPhone and Android Phone. The app is available for download from the Apple App Store and Google App Marketplace.

How to access Fluke Connect:

1. Insert the Fluke Connect Wireless SD Card into the Imager.
3. Power on the Imager.
4. On your smartphone, go to Settings > Wi-Fi.
5. Select the Wi-Fi network that begins with "Fluke..".
6. Go to the Fluke Connect App and select "Thermal Imager" from the list.

You are now able to take images on the Imager.

4. Pull the trigger on the Imager to capture the image. The image is now in the buffer and you can save or edit.
5. Push to save the image and view the image on the phone app.

Go to www.flukeconnect.com for more information about how to use the app.

CNX™ Wireless System

The Imager supports the Fluke CNX™ Wireless System (may not be available in all regions). It can discover up to 10 3000 Series wireless tools up to 20 meters away. From those 10, you can select 5 tools to view their live measurements on the Imager display.

To discover a supported tool:







1. If not already on, turn on each wireless tool and make sure the wireless feature is enabled. See the documentation of each tool for more information about how to use.
2. Turn on the Imager.
3. Push **F2**.
4. Push **▲**/**▼** to highlight **Camera**.
5. Push **F1** or **▶▶** to view the menu.
6. Push **▲**/**▼** to highlight **CNX**.
7. Push **F1** or **▶▶** to view the menu.
8. Push **▲**/**▼** to highlight **ON**.
9. Push **F1** or **▶▶** start the discovery process.

When done, the Imager presents a list with the ID and name of available tools found within the 20 m distance.

10. Push **▲**/**▼** to highlight a tool name.
11. Push **F1** to select the tool.
12. Repeat steps 10 and 11 for each tool to show on the display.
13. Push **F2** when done.

The labels change to include an Edit function. By default, the Imager shows and saves the data for the selected tools. If these settings are acceptable, push **F2** to exit the CNX setup menu.

To edit the selection:

14. Push / to highlight the tool name.
15. Push  or  to view the Edit menu. The Edit menu gives you a choice to display the measurement data and/or save it to the SD memory card.
16. Push  to accept the change.
17. Push  when done to exit the menu.











The display updates to show the wireless icon and live measurement for each selected wireless tool.

Memory Menu

The Memory Menu allows the user to review captured images and videos, as well as audio annotations and IR-PhotoNotes in a thumbnail view format.





Review Data Files

To view stored images on the SD memory card:

1. Push .
2. Push / to highlight **Memory**.
3. Push  or  to view the memory menu.
4. Push     to highlight the thumbnail of the file for review.
5. Push  to review the file.

Delete Data Files

To erase one image from the SD memory card:

1. Push **F2**.
2. Push / to highlight **Memory**.
3. Push **F1** or  to view the memory menu.
4. Push     to highlight the thumbnail of the file to delete.
5. Highlight **Selected Image** and push . The Imager prompts you to continue or cancel.
6. Push **F1** to delete the file.

To erase all the images from the SD memory card:

1. Push **F2**.
2. Push / to highlight **Memory**.
3. Push **F2**.
4. Highlight **All Image** and push . The Imager prompts you to continue or cancel.
5. Push **F1** to delete all files on the SD memory card.

Settings Menu

The Settings menu has adjustments for user preferences such as units of temperature measurement, file format of stored data, auto off settings, date, time, and language. This menu also has a section that displays information about the Imager such as model number, serial number, and firmware versions.

Units

To change the temperature units:







1. Push **F2**.
2. Push **▲**/**▼** to highlight **Settings**.
3. Push **F1** or **▶▶** to view the menu.
4. Push **▲**/**▼** to highlight **Units**.
5. Push **F1** or **▶▶** to view the menu.
6. Push **▲**/**▼** to highlight an option.
7. Push:
 - **F1** to set the change and go back to the live view.
 - **F2** or **◀◀** to set the change and go back to the previous menu.
 - **F3** to cancel the change and go back to the live view.

File Format

Data can be saved to the SD memory card in different file formats. Image format selections are .bmp, .jpg, and .is2. Video format selections are .avi and .is3. These selections remain valid when you turn the Imager off or on.

To change the file format:

1. Push **F2**.
2. Push **▲**/**▼** to highlight **Settings**.

3. Push **F1** or  to view the menu.
4. Push / to highlight **File Format**.
5. Push **F1** or  to view the menu.
6. Push / to highlight an option.
7. Push **F1** to set the option.
8. Push:
 - **F1** to set the change and go back to the live view.
 - **F2** or  to set the change and go back to the previous menu.
 - **F3** to cancel the change and go back to the live view.

Images saved in the .is2 file format have the consolidation of all data into a single file and are more flexible for analysis and modification in the included SmartView software. This file format consolidates the infrared image, radiometric temperature data, visible image, voice annotation, and IR-PhotoNotes into one location.

For situations where a smaller file size with maximum resolution is needed and modification is not, choose the .bmp file format. For the smallest file size where modification is not needed and image quality and resolution are not as important, choose the .jpg file format.

The .bmp and .jpg files can be emailed and then opened on most PC and MAC systems without special software. These formats do not allow full analysis capabilities or modification.

The .is2 file format can be emailed and then opened with SmartView Software. This format has the maximum versatility. Visit the Fluke website or contact Fluke to find out how to download SmartView analysis and reporting software at no charge.

Auto Off

Auto Off is set as off or on. When set to on, the Imager goes into the Sleep mode after 5 minutes of inactivity. After 20 minutes of inactivity the Imager turns off.

Note

When the battery is connected to AC Power, or the unit is in video mode, the Sleep Mode/Auto Off feature is automatically disabled.

To set or disable the Auto Off feature:

1. Push **F2** .
2. Push **▲**/**▼** to highlight **Settings**.
3. Push **F1** or **▶▶** to view the menu.
4. Push **▲**/**▼** to highlight **Auto Off**.
5. Push **F1** or **▶▶** to view the menu.
6. Push **▲**/**▼** to highlight an option.
7. Push **F1** to set the option.
8. Push:
 - **F1** to go back to the live view.
 - **F2** or **◀◀** to set the change and go back to the previous menu.
 - **F3** to cancel the change and go back to the live view.

When the Auto off feature is disabled and the Imager is left on, the Imager stays on until the battery is depleted.

Date







The date can be displayed in one of two formats: **MM/DD/YY** or **DD/MM/YY**.

To set the date:









1. Push **F2**.
2. Push **▲**/**▼** to highlight **Settings**.
3. Push **F1** or **▶▶** to view the menu.
4. Push **▲**/**▼** to highlight **Date**.
5. Push **▲**/**▼** to highlight date format.
6. Push **F1** or **▶▶** to view the menu.
7. Push **F1** to set the date format.
8. Push **▲** or **▼** to change the setting.
9. Push **▶▶** to move to the next setting.
10. Push **▲** or **▼** to change the setting.
11. Push **▶▶** to move to the next setting.
12. Push **▲** or **▼** to change the setting.
13. Push:
 - **F1** to set the change and go back to the live view.
 - **F2** or **◀◀** to set the change and go back to the previous menu.
 - **F3** to cancel the change and go back to the live view.

Time

To set the time:

1. Push **F2**.
2. Push / to highlight **Settings**.
3. Push **F1** or  to view the menu.
4. Push / to highlight **Time**.
5. Push **F1** or  to view the menu.

Time displays in two different formats: 24 hour or 12 hour. To set the time format:









1. Push / to highlight time format.
2. Push **F1** or  to view the menu.
3. Push  or  to change the setting.
4. Push  to move to the next setting.
5. Push  or  to change the setting.

The 12 hour format has a selection for setting whether the time is AM or PM. To set AM or PM:

6. Push:
 - **F1** to set the change and go back to the live view.
 - **F2** or  to set the change and go back to the previous menu.
 - **F3** to cancel the change and go back to the live view.

Language

To change the display to a different language:

1. Push **F2**.
2. Push / to highlight **Settings**.
3. Push **F1** or  to view the menu.
4. Push / to highlight **Language**.
5. Push **F1** or  to view the menu.
6. Push  or  to change the setting.
7. Push **F1** to set a new language.
8. Push:
 - **F1** to set the change and go back to the live view.
 - **F2** or  to set the change and go back to the previous menu.
 - **F3** to cancel the change and go back to the live view.

Imager Information

You can access information about the Imager from the Settings Menu. This includes:

- Model
- Camera serial number
- Refresh rate
- Engine serial number
- Firmware version
- FPGA #
- Factory calibration date
- Production date

To display the Imager Info:

1. Push **F2** .
2. Push **▲**/**▼** to highlight **Settings**.
3. Push **F1** or **▶▶** to view the menu.
4. Push **▲**/**▼** to highlight **Imager Info**.
5. Push **F1** or **▶▶** to view the menu.
6. Push **▲**/**▼** to scroll through the menu.
7. Push:
 - **F1** to set the change and go back to the live view.
 - **F2** or **◀◀** to set the change and go back to the previous menu.
 - **F3** to cancel the change and go back to the live view.

Maintenance

The Imager does not require maintenance.

⚠⚠ Warning

To prevent eye damage and personal injury, do not open the Product. The laser beam is dangerous to eyes. Have the Product repaired only through an approved technical site.

How to Clean the Case

Clean the case with a damp cloth and a weak soap solution. Do not use abrasives, isopropyl alcohol, or solvents to clean the case or lens/window.

Battery Care

Warning

To prevent personal injury and for safe operation of the Product:

- Do not put battery cells and battery packs near heat or fire. Do not put in sunlight.
- Do not disassemble or crush battery cells and battery packs.
- Remove batteries to prevent battery leakage and damage to the Product if it is not used for an extended period.
- Connect the battery charger to the mains power outlet before the charger.
- Use only Fluke approved power adapters to charge the battery.
- Keep cells and battery packs clean and dry. Clean dirty connectors with a dry, clean cloth.

Caution

To prevent damage:

- Do not expose Product to heat sources or high-temperature environments such as an unattended vehicle in the sun.
- Do not store the Imager on the charger for more than 24 hours as reduced battery life may result.
- Charge the Imager for a two-hour minimum at six-month intervals for maximum battery life. Without use, the battery will self-discharge in approximately six months. Batteries stored for long periods will need two to ten charging cycles for full capacity.
- Always operate in the specified temperature range.

Caution

Do not incinerate the Product and/or battery. Go to Fluke's website for recycling information.

General Specifications

Temperature

Operating	-10 °C to +50 °C (14 °F to 122 °F)
Storage	-20 °C to +50 °C (-4 °F to +122 °F) without batteries
Charging	0 °C to 40 °C (32 °F to 104 °F)

Relative Humidity 10 to 95 % non-condensing

Altitude

Operating	2,000 m
Storage	12,000 m

Display Color LCD, 3.5" diagonal (Portrait orientation) with Backlight (selectable high, medium, low)

Software SmartView® full analysis and reporting software available for free download at www.fluke.com.

Power

Battery Lithium-ion rechargeable smart battery pack with 5-segment LED display to show charge level. Lithium-ion battery pack meets the requirements of UN Tests and Criteria Manual, Part III, Subparagraph 38.3.

Battery Life 4+ hours continuous use for each battery pack (assumes 50 % brightness of LCD)

Battery Charge Time 2.5 hours to full charge

Battery Charging Ti SBC3 Two Bay Battery Charger rated: 10-15 Vdc 2 A or charge battery pack in Imager with included ac adapter rated: 100-240 Vac 50/60 Hz, 15 V 2 A. Optional 12 V Automotive charging adapter.

Battery Charging Temperature 0 °C to 40 °C

AC Operation AC operation with included power supply: 110 – 240 Vac, 50/60 Hz 15 V 2 A

Power Saving Sleep Mode activated after 5 minutes of inactivity
Automatic Power Off after 20 minutes of inactivity

Safety Standards

CAN/CSA, UL	C22.2 No. 61010-1, UL STD 61010-1
EU	EN61010-1, pollution degree 2, CAT none

Electromagnetic Compatibility (EMI, EMC)

US	FCC Part 15 Subpart B
EN61326-1	Electromagnetic Environment Controlled
Korea (KCC)	Class A Equipment (Industrial Broadcasting & Communication Equipment)

This product meets requirements for industrial (Class A) electromagnetic wave equipment and the seller or user should take notice of it. This equipment is intended for use in business environments and not to be used in homes.

Radio Standards

US	47 CFR 15.207, 15.209, 15.249, FCCID: T68-F125
Canada	RSS210, IC: 6627A-F125
EU	EN300.328, EN301.489

Vibration 2 G, IEC 68-2-26

Shock 25 G, IEC 68-2-29

Laser Pointer IEC 60825-1:2007 Class II, FDA LFR 1040.10 Class II, JQA JIS C 6802

Drop 2 meter

Size (H x W x L) 28.4 x 8.6 x 13.5 cm
 (11.2 x 3.4 x 5.3 in)

Weight 72.6 kg (1.6 lb)

Enclosure Rating IP54

Warranty 2 years

Calibration Cycle 2 years (assumes normal operation and normal aging)

Supported Languages Czech, Dutch, English, Finnish, French, German, Hungarian, Italian, Japanese, Korean, Polish, Portuguese, Russian, Simplified Chinese, Spanish, Swedish, Traditional Chinese, and Turkish

Detailed Specifications

Temperature Measurements

Temperature Range (not calibrated below -10 °C)	
Ti90, Ti95, Ti100, Ti105, Ti110	-20 °C to +250 °C
Ti125	-20 °C to +350 °C
TiR105, TiR110, TiR125.....	-20 °C to +150 °C
Accuracy.....	±2 °C or 2 % (whichever is greater) at 25 °C ambient
Measurement Modes.....	Smooth Auto-Scaling and Manual Scaling
On-screen Emissivity Correction	all models

Imaging Performance

Field of View	
Ti100, Ti105, Ti110, Ti125, TiR110, TiR125 ...	31 ° x 22.5 °
Ti95	26 ° x 26 °
Ti90	19.5 ° x 26 °

Spatial Resolution	
Ti100, Ti105, Ti110, Ti125, TiR110, TiR125 (IFOV).....	3.39 mRad
Ti90, Ti95 (IFOV).....	5.6 mRad

Minimum Focus Distance	
Ti100, Ti105, TiR105.....	122 cm (approx. 48 in)
Ti90, Ti95	46 cm (approx. 18 in)
Ti110, Ti125, TiR110, TiR125	15 cm (approx. 6 in)

Focus	
Ti90, Ti95, Ti100, Ti105, TiR105.....	Focus-free
Ti110, Ti125, TiR110, TiR125	IR-OptiFlex™ focus

Image Capture or Refresh Rate	
Ti90, Ti95, Ti100, TiR105, TiR110, TiR125.....	9 Hz
Ti105, Ti110, Ti125	9 Hz or 30 Hz (factory set)

Detector Type (Focal Plane Array, uncooled microbolometer)	
Ti100, Ti105, Ti110, Ti125, TiR110, TiR125 ...	160 X 120
Ti95	80 x 80
Ti90	80 x 60

Thermal Sensitivity (NETD)	
Ti90	150 mK
Ti95, Ti100, Ti105, Ti110, Ti125	≤100 mK (0.1 °C at 30 °C target temperature)
TiR105, TiR110, TiR125.....	≤80 mK (0.08 °C at 30 °C target temperature)

Image Presentation

Standard Palettes

Ti90.....	Ironbow, Blue-Red, Grayscale
Ti95.....	Blue-red, Grayscale, High-Contrast, Hot Metal, Ironbow, Amber
Ti100.....	Ironbow, Blue-Red, Grayscale, Amber
Ti105, Ti110, Ti125, TiR105, TiR110, TiR125.....	Blue-Red, Grayscale, Inverted Grayscale, High Contrast, Amber, Inverted Amber, Hot Metal, Ironbow

Ultra Contrast™ Palettes

Ti110, TiR110.....	Ironbow, Blue-Red, Grayscale
Ti125, TiR125.....	Blue-Red, Grayscale, Inverted Grayscale, High Contrast, Amber, Inverted Amber, Hot Metal, Ironbow

Level and Span

Smooth Auto-Scaling and Manual scaling of level and span

Minimum Span (in manual mode)

Ti90, Ti95, Ti100, Ti105, Ti110, Ti125.....	2.5 °C
TiR105, TiR110, TiR125.....	2.0 °C

Minimum span (in auto mode)

Ti90, Ti95, Ti100, Ti105, Ti110, Ti125.....	5 °C
TiR105, TiR110, TiR125.....	2.5 °C

IR-Fusion® Information

Max IR (Full Thermal).....	Ti90, Ti95, Ti100, Ti105, Ti110, Ti125, TiR105, TiR110, TiR125
----------------------------	--

AutoBlend™

min mode.....	Ti110, Ti125, TiR110, TiR125
mid mode.....	Ti105, Ti110, Ti125, TiR105, TiR110, TiR125

Picture-in-Picture

min mode.....	Ti110, Ti125, TiR110, TiR125
mid mode.....	Ti105, Ti110, Ti125, TiR105, TiR110, TiR125
max mode.....	Ti95, Ti105, Ti110, Ti125, TiR105, TiR110, TiR125

Full Visible.....	Ti90, Ti95, Ti105, Ti110, Ti125, TiR105, TiR110, TiR125
-------------------	---

Voice AnnotationTi110, Ti125, TiR110, TiR125

Video Recording

Standard Video RecordingTi110, Ti125, TiR110, TiR125

Radiometric Video Recording.....Ti125, TiR125

Streaming Video (Remote Display).....Ti125, TiR125

Image and Data Storage

Image Capture, Review, Save MechanismOne-handed image capture, review, and save capability

Storage MediumSD Memory Card (included memory card will store at least 1200 fully radiometric (.is2) IR and linked visual images each with 60 seconds voice annotations or 3000 basic (.bmp or .jpg) images, transferable to PC through included multiformat USB card reader or USB cable

Note

The addition of IR-PhotoNotes, standard video, or radiometric video may vary the total number of images that can be stored on the SD memory card.

File FormatsNon-Radiometric (.avi, .bmp, .jpg) or Fully-Radiometric (.is2, .is3)
 No analysis software required for Non-Radiometric (.avi, .bmp, .jpg) files

Export File Formats with SmartView® SoftwareJPEG, JPG, JPE, JFIF, BMP, GIF, DIB, PNG, TIF, TIFF

Memory Review.....Thumbnail view navigation and review selection